

▶ 主要諸元 (型式: SL6000J-2)

項目		仕様	STANDARD (STD)	HEAVY LIFT (HL)	SUPER HEAVY LIFT (SHL)
ヘビーブーム	最大つり上げ能力	t×m	500×6.2	370×8.3	500×8.3
	ブーム長さ	m	21~84	36~84	36~84
メインブーム (ラフティング上部)	最大つり上げ能力	t×m	300×10	300×9.3	300×20
	ブーム長さ	m	30~84	36~84	36~84
ロングブーム	ブーム長さ	m	90~108		90~126
ラフティングジブ	最大つり上げ能力	t×m	195.1×14.0	200×14.4	200×14.4
	最大ブーム+ジブ長さ	m	66+72* ¹	66+72	84+84
	ラフティングブーム角度		66° ~ 86°		
能力増大装置(HLマスト)長さ		m	—	30	30
ロープ速度	巻上1	m/min	*110 ~ 3		
	巻上2	m/min	*110 ~ 3		
	起伏1	m/min	*(2×28) ~ 2		
	起伏2	m/min	*30 ~ 2		
	起伏3	m/min	*40 ~ 2		
旋回速度		min ⁻¹ {rpm}	0.9 {0.9}		
走行速度		km/h	*1.0/0.6		
作業時質量(基本姿勢)		t	468	481	481* ²
接地圧(基本姿勢)		kPa{kgf/cm ² }	151 {1.5}	154 {1.6}	154 {1.6}
登坂能力(tanθ)		%(度)	20%(11.3)		0.8%(0.5)
定格ラインプル		kN{tf}	137 {14.0}		
エンジン	名称		日野E13C-VV		
	定格出力	kW/min ⁻¹	320/2,000		
ワイヤロープ	巻上1	mm	φ28		
	巻上2	mm	φ28		
	起伏1	mm	φ28		
	起伏2	mm	φ28		
	起伏3	mm	φ28		

各ロープ速度はドラム1層目での値です。

*印の速度は軽負荷の時の値であり、負荷により速度の変動があります。

※1印のラフティングブーム+ジブ長さには、12m中間HLマストが必要です。

※2印の質量にはパレットウエイト質量は含んでおりません。

単位は国際単位系のSI単位で、{ }内は従来表示です。

▶ 全体図 (単位 : mm)

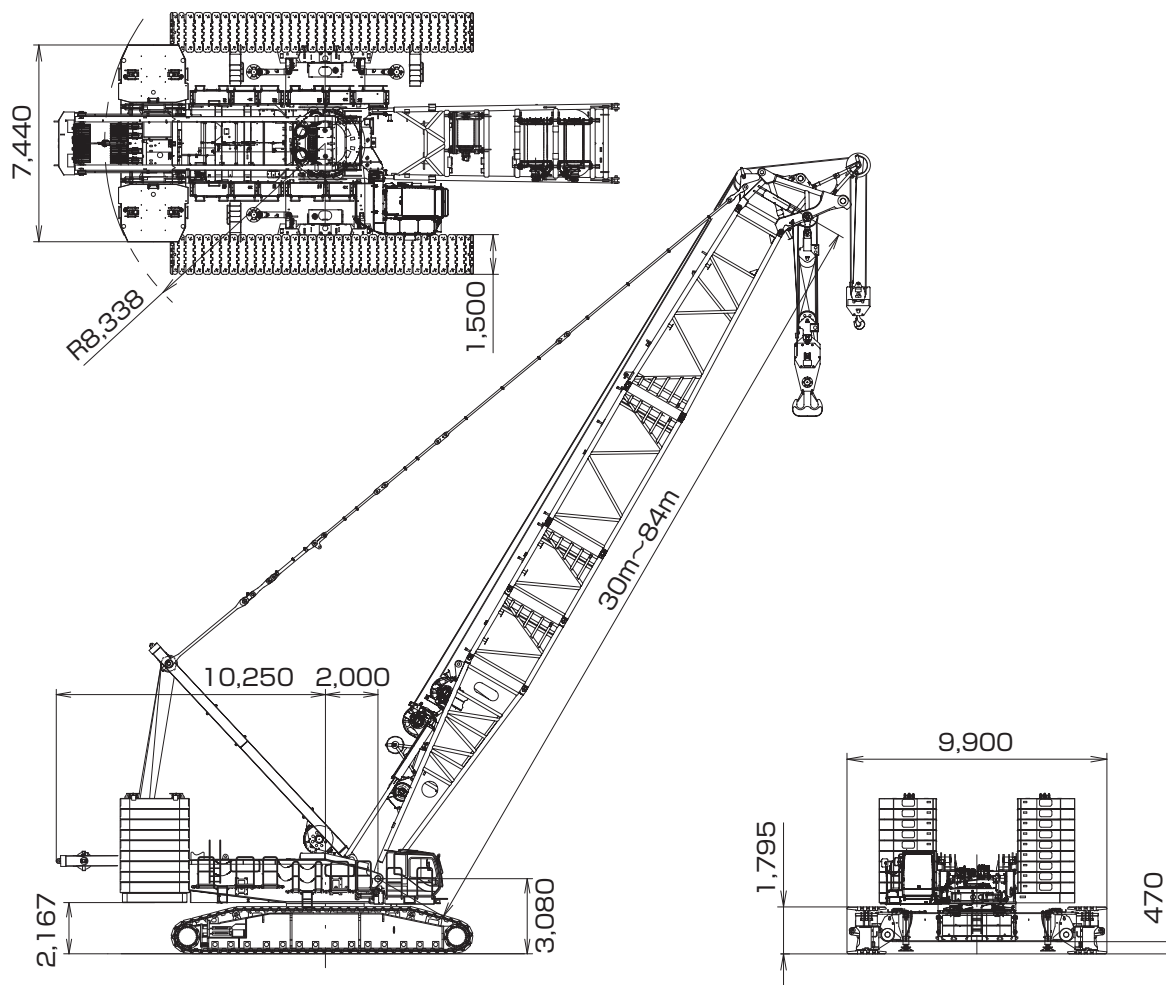

▶ 能力増大装置付仕様

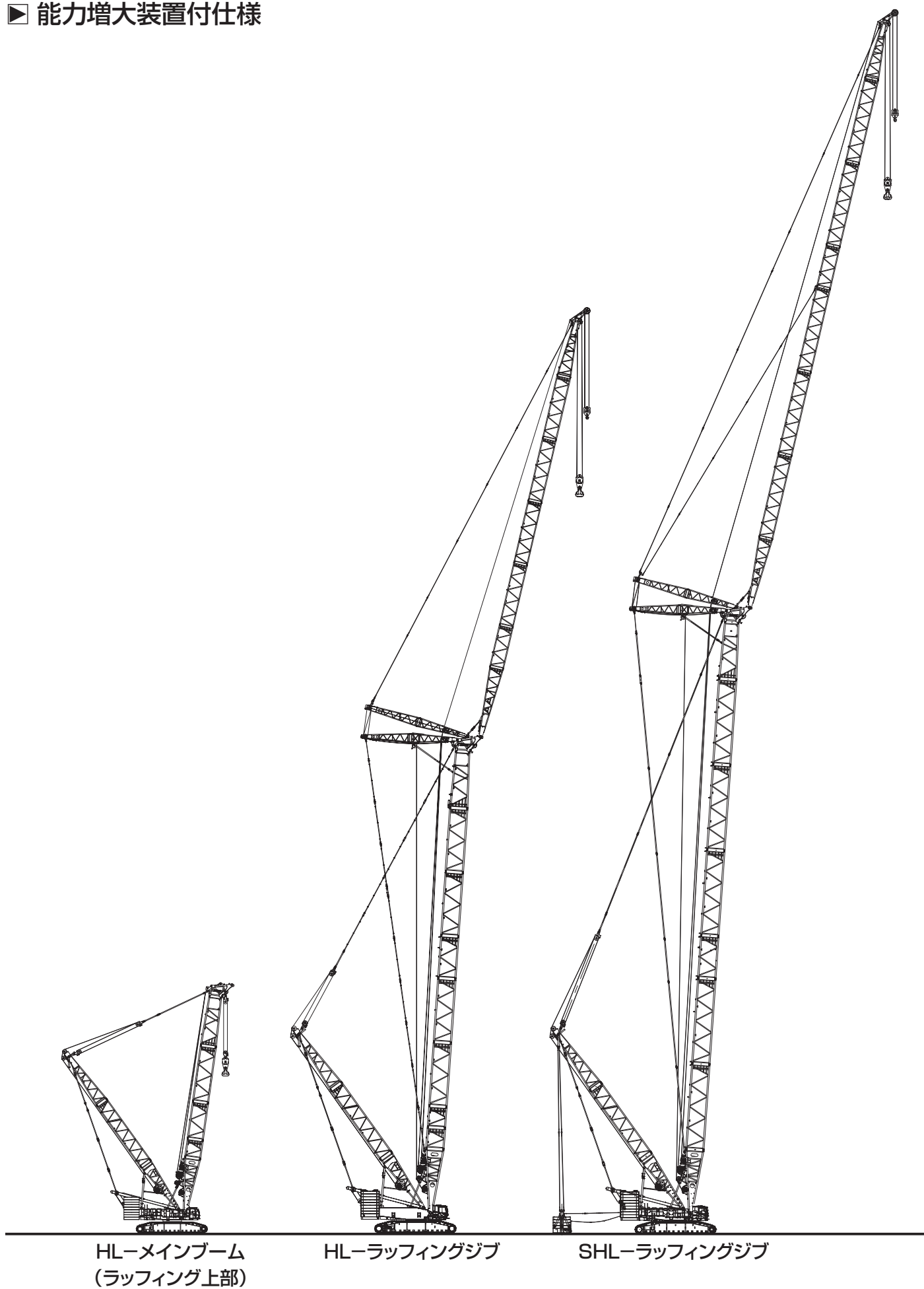

HL-メインブーム
(ラフティング上部)

HL-ラフティングジブ

SHL-ラフティングジブ

▶ 仕様とアタッチメント (アタッチメントの互換性)

仕様	STANDARD(STD)						HEAVY LIFT(HL)				SUPER HEAVY LIFT(SHL)				
	クレーン			ラフティングジブ			クレーン			ラフティングジブ	クレーン			ラフティングジブ	
	ヘビーブーム	メインブーム (ラフティング上部)	ロングブーム				ヘビーブーム	メインブーム (ラフティング上部)	ロングブーム		ヘビーブーム	メインブーム (ラフティング上部)	ロングブーム		
最長ブーム(+ジブ)長さ	84m	84m	108m	60m+54m	66m+72m	84m	84m	108m	66m+72m	84m	84m	126m	84m+84m		
カウンタウエイト	カウンタウエイト(上部本体)	200 t						200 t				200 t			
	カーボディウエイト	50 t						50 t				50 t			
ブーム	9m下部ブーム	共用(1)	共用(1)	共用(1)	共用(1)	共用(1)	共用(1)	共用(1)	共用(1)	共用(1)	共用(1)	共用(1)	共用(1)	共用(1)	
	1m上部ブーム(ヘビー)	ヘビー専用(1)	-	-	-	-	ヘビー専用(1)	-	-	-	ヘビー専用(1)	-	-	-	
	1m上部ブーム(ラフティング)	-	共用(1)	-	共用(1)	共用(1)	-	共用(1)	-	共用(1)	-	共用(1)	-	共用(1)	
	3m中間ブーム	共用(2)	共用(2)	-	共用(2)	共用(1)	共用(2)	共用(2)	-	共用(2)	共用(2)	共用(2)	共用(2)	共用(2)	
	6m中間ブーム	共用(1)	共用(1)	共用(1)	共用(1)	共用(1)	共用(1)	共用(1)	共用(1)	共用(1)	共用(1)	共用(1)	共用(1)	共用(1)	
	9m中間ブーム	共用(6)	共用(6)	共用(6)	共用(4)	共用(3)	共用(6)	共用(6)	共用(6)	共用(4)	共用(6)	共用(6)	共用(6)	共用(6)	
	8m中間テーパーブーム	共用(1)	共用(1)	共用(1)	共用(1)	共用(1)	共用(1)	共用(1)	共用(1)	共用(1)	共用(1)	共用(1)	共用(1)	共用(1)	
ラフティングジブ	10m下部ラフティングジブ	-	-	-	ジブ専用(1)	ジブ専用(1)	-	-	-	ジブ専用(1)	-	-	-	ジブ専用(1)	
	8m上部ラフティングジブ	-	-	共用(1)*1	共用(1)	共用(1)	-	-	共用(1)*1	共用(1)	-	-	共用(1)*1	共用(1)	
	3m中間ラフティングジブ	-	-	共用(1)*2	共用(1)	共用(1)	-	-	共用(1)*2	共用(1)	-	-	共用*2	共用(2)	
	6m中間ラフティングジブ	-	-	共用(1)*2	共用(1)	共用(1)	-	-	共用(1)*2	共用(1)	-	-	共用*2	共用(1)	
	9m中間ラフティングジブ	-	-	共用(1)*2	共用(3)	共用(5)	-	-	共用(1)*2	共用(5)	-	-	共用*2	共用(6)	
	5mロング中継ブーム	-	-	ロング専用(1)	-	-	-	-	ロング専用(1)	-	-	-	ロング専用(1)	-	
HLマスト	9m下部HLマスト	-	-	-	-	-	共用(1)			-	-	-	共用(1)		
	9m上部HLマスト	-	-	-	-	-	共用(1)			-	-	-	共用(1)		
	12m中間HLマスト	-	-	-	-	共用(1)*3	共用(1)			-	-	-	共用(1)		

ーのブームは共用ではありません。

()内の数字は、各最長長さ時の使用本数を示します。

*1 ロングブーム仕様では上部ブームとして使用します。

*2 ロングブーム仕様では中間ブームとして使用します。

*3 STD-ラフティングジブ仕様の66mブームの構成では中間ブームとして使用します。

▶ フック巻上限界 (単位 : m)

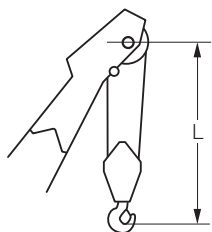

使用フック	L		
	ヘビーブーム/ メインブーム(ラフティング上部)	ロングブーム	ラフティングジブ
500tフック	7.9	-	-
300tフック	7.3	-	-
200tフック(つり下げシーフ付きの場合)	7.3	-	8.7
200tフック(つり下げシーフ無しの場合)	5.0	-	6.5
120tフック	4.5	7.3	6.0
70tフック	4.5	7.3	6.0
40tフック	4.2	7.0	5.7
14tボールフック	6.3	5.3	5.7

STANDARD

▶ 定格総荷重

- 定格総荷重とは、水平堅土上における転倒荷重の78%以内で、フックブロック、玉掛用ワイヤロープ等のつり具の質量を含んだ値です。
- 作業半径とはクレーン旋回中心よりつり上荷重の重心までの水平距離を意味します。
- 実際につり上げ得る荷重は定格総荷重から（フック＋玉掛用ワイヤロープ等のつり具）の質量を差し引いた値になります。
- 定格総荷重をつる場合にも風の影響、地盤の状態、作業速度その他安全作業に有害な状況がある時はオペレータは荷重の軽減、作業速度を遅くするなど状況に応じた判断をする責任があります。
- 表中の空欄の個所では作業を行うことができません。
- すべてのブーム長さにおける中間ブームの構成は取扱説明書の指示を厳守してください。
- 主ブームに補助シーブを取り付けたままで主フックを使用する場合の定格総荷重は、主ブーム定格総荷重から、一律0.7t差し引いた値となります。ただし最小定格総荷重はメインブーム（ラフティング上部）は7.7t、ロングブームは6.2tとします。
- 補助シーブを装着できる主ブーム長さは下記のとおりです。
[STANDARD]
メインブーム（ラフティング上部）：30.0m～84.0m
ロングブーム：90.0m～102.0m
- ラフティングジブが装着された状態では、主ブームづりはできません。
- 巻上げロープ巻掛本数に対する最大巻上荷重とフックの質量

フック 呼称	最大巻上荷重 (t)																				フック 質量	
	1本掛	2本掛	3本掛	4本掛	5本掛	6本掛	7本掛	8本掛	9本掛	10本掛	11本掛	12本掛	13本掛	14本掛	15本掛	16本掛	20本掛	24本掛	28本掛	36本掛		44本掛
500t	-	-	-	-	-	-	-	112	-	-	-	164	-	-	-	220	280	336	370	450	500	11.7t
300t	-	-	-	-	-	-	-	112	-	-	-	164	-	-	-	220	280	300	-	-	-	7.8t
200t	-	28	42	56	70	84	98	112	126	140	152	164	174	184	192	200	-	-	-	-	-	7.1t
120t	-	28	42	56	70	84	98	112	120	-	-	-	-	-	-	-	-	-	-	-	-	4.5t
70t	-	28	42	56	70	-	-	-	-	-	-	-	-	-	-	-	-	-	-	-	-	3.1t
40t	-	28	40	-	-	-	-	-	-	-	-	-	-	-	-	-	-	-	-	-	-	2.0t
14t ボールフック	14	-	-	-	-	-	-	-	-	-	-	-	-	-	-	-	-	-	-	-	-	0.9t

500t、300tフックはダブルドラムの値です。

- ストラットガイラインをブーム上面に搭載した状態で作業する場合の定格総荷重は、定格総荷重表から下表の値を差し引いた値となります。

ヘビーブーム、ラフティング上部

ブーム長さ (m)	21	24	30	36	42	48	54	60	66	72	78	84
差し引き能力 (t)	0.2	0.4	0.5	0.7	0.9	1.0	1.2	1.4	1.5	1.7	1.9	2.1

ロングブーム

ブーム長さ (m)	90	96	102	108
差し引き能力 (t)	1.7	1.7	1.8	1.8

STANDARD

▶ ブームおよびガイラインの構成

■ ヘビーブーム

ブームの種類		
記号	ブーム長さ	仕様
	9.0m	下部ブーム
	3.0m	ブーム
	6.0m	ブーム
	9.0m	ブーム
	8.0m	テーパブーム
	3.0m	ヘビー上部ブーム

記号	ガイライン		形式
	径 (mm)	長さ (m)	
A	—	3.00	リンクアッセン
B	—	6.00	リンクアッセン
C	—	9.00	リンクアッセン
E	—	8.00	リンクアッセン
k	—	L1 : 0.37 L2 : 0.80 L3 : 0.23 L4 : 2.02 L5 : 0.48	リンク

※印は、これより短いブームの組立可能な構成を示します。

ブーム長さ	ブーム及びガイライン構成
21m	
24m	
30m	※
36m	※
42m	※
48m	※
54m	※
60m	※
66m	※
72m	※
78m	※
84m	※

■ メインブーム (ラフティング上部)

ブームの種類		
記号	ブーム長さ	仕様
	9.0m	下部ブーム
	3.0m	ブーム
	6.0m	ブーム
	9.0m	ブーム
	8.0m	テーパブーム
	1.0m	ラフティング上部ブーム

記号	ガイドライン		形式
	径 (mm)	長さ (m)	
A	—	3.00	リンクアッセン
B	—	6.00	リンクアッセン
C	—	9.00	リンクアッセン
E	—	8.00	リンクアッセン
k	—	L1 : 0.37 L2 : 0.80 L3 : 0.23 L4 : 2.02 L5 : 0.48	リンク

※印は、これより短いブームの組立可能な構成を示します。

ブーム長さ	ブーム及びガイドライン構成
30m	
36m	
42m	
48m	
54m	
60m	
66m	
72m	
78m	
84m	

STANDARD

▣ ロングブーム

ブームの種類		
記号	ブーム長さ	仕様
	9.0m	下部ブーム
[6.0]	6.0m	ブーム
[9.0]	9.0m	ブーム
[8T]	8.0m	テーパブーム
[60]	3.0m	ジブ兼用
[6.0L]	6.0m	ジブ兼用
[9.0L]	9.0m	ジブ兼用
[5TL]	5.0m	ジブ兼用テーパブーム
UL	8.0m	上部ジブ兼用

記号	ガイドライン		形式
	径 (mm)	長さ (m)	
B	—	6.00	リンクアッセン
C	—	9.00	リンクアッセン
E	—	8.00	リンクアッセン
k	—	L1 : 0.37 L2 : 0.80 L3 : 0.23 L4 : 2.02 L5 : 0.48	リンク
P	φ44	7.20	ケーブル
J	φ44	3.00	ケーブル
K	φ44	6.00	ケーブル
L	φ44	9.00	ケーブル
R	φ44	4.50	ケーブル
Mb	—	0.90	リンクアッセン
	φ44	4.60	ガイドライン
	—	1.10 0.78 0.78	リンク
q	—	0.50	リンクアッセン

※印は、これより短いブームの組立可能な構成を示します。

ブーム長さ	ブーム及びガイドライン構成
90m	
96m	
102m	
108m	

ラッピングジブ





ブームの種類		
記号	ブーム長さ	仕様
	9.0m	下部ブーム
	3.0m	ブーム
	6.0m	ブーム
	9.0m	ブーム
	12.0m	12m中間マスト
	8.0m	テーパブーム
	3.0m	ラッピング上部ブーム

記号	ガイドライン		形式
	径 (mm)	長さ (m)	
A	—	3.00	リンクアッセン
B	—	6.00	リンクアッセン
C	—	9.00	リンクアッセン
D	—	12.00	リンクアッセン
E	—	8.00	リンクアッセン
k	—	L1 : 0.37 L2 : 0.80 L3 : 0.23 L4 : 2.02 L5 : 0.48	リンク
Ma	—	0.90	リンクアッセン
	φ44	6.00	ケーブル
	—	0.34	リンク
	—	0.98	リンク
m	—	3.00	リンクアッセン
n	—	1.00	リンク

※印は、これより短いブームの組立可能な構成を示します。

ブーム長さ	ブーム及びガイドライン構成
30m	
36m	
42m	
48m	
54m	
60m	
66m	

STANDARD

ジブの種類		
記号	ジブ長さ	仕様
	10.0m	下部ジブ
	3.0m	ジブ
	6.0m	ジブ
	9.0m	ジブ
	8.0m	上部ジブ

記号	ガイドライン		形式
	径 (mm)	長さ (m)	
J	φ44	3.00	ケーブル
K	φ44	6.00	ケーブル
L	φ44	9.00	ケーブル
P	φ44	7.20	ケーブル
N	φ44	10.00	ケーブル
Ma	—	0.90	リンクアッセン
	φ44	6.00	ケーブル
	—	0.34	リンク
	—	0.98	リンク
m	—	3.00	リンクアッセン
n	—	1.00	リンク

※印は、これより短いブームの組立可能な構成を示します。

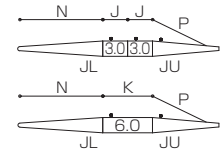
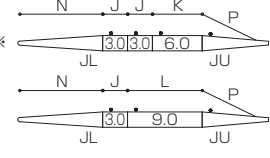
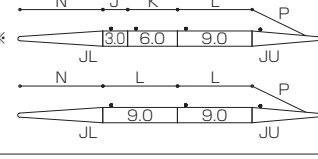
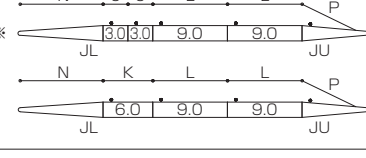
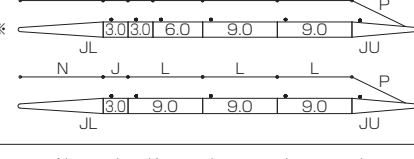
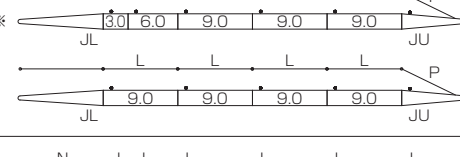
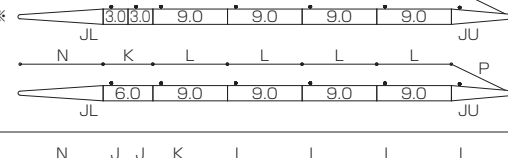
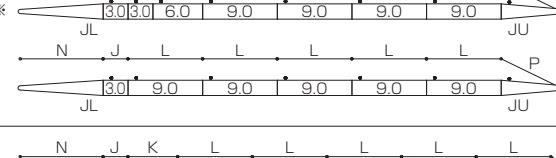
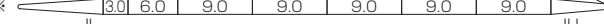
ジブ長さ	ジブ及びガイドライン構成
24m	
30m	<p>※</p> 
36m	<p>※</p> 
42m	<p>※</p> 
48m	<p>※</p> 
54m	<p>※</p> 
60m	<p>※</p> 
66m	<p>※</p> 
72m	<p>※</p> 

STANDARD

▶ クレーン作動範囲図

▶ ヘビーブーム

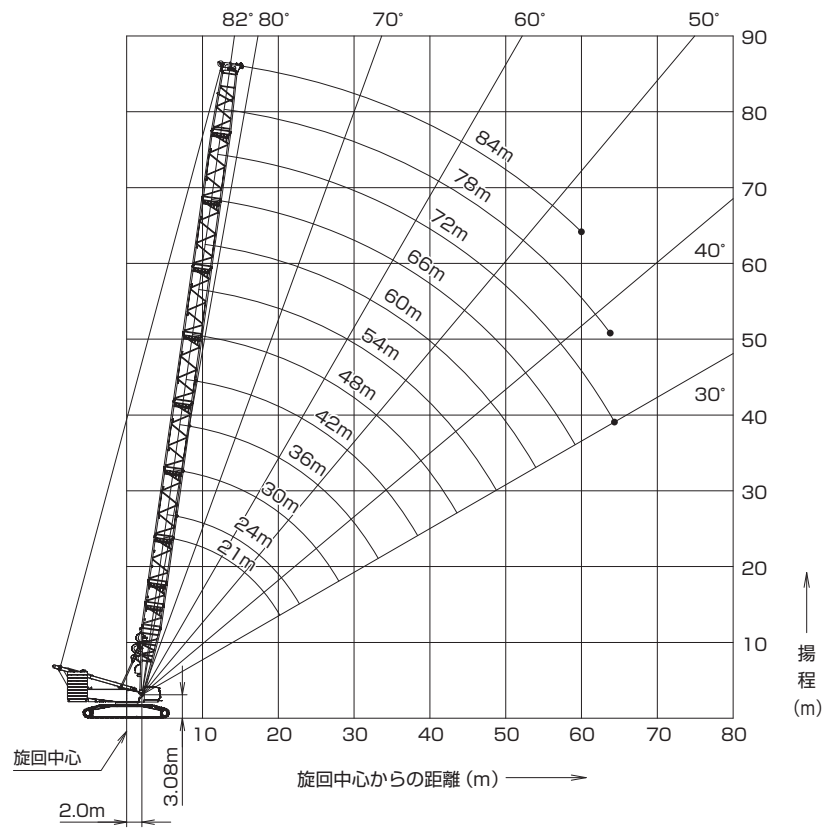

▶ メインブーム (ラフティング上部)

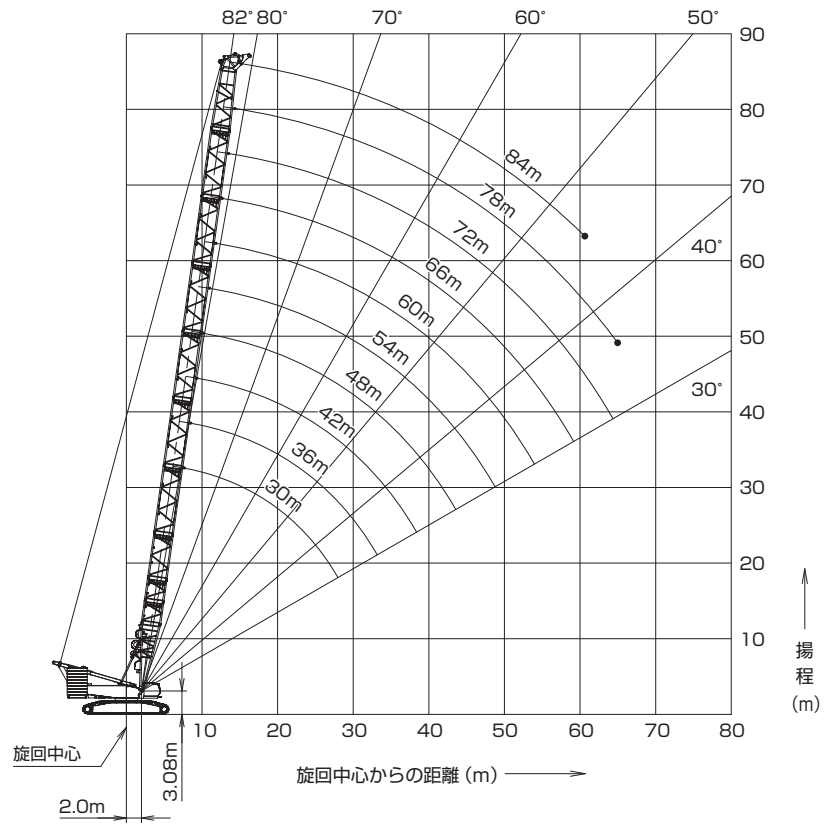

▶ ロングブーム

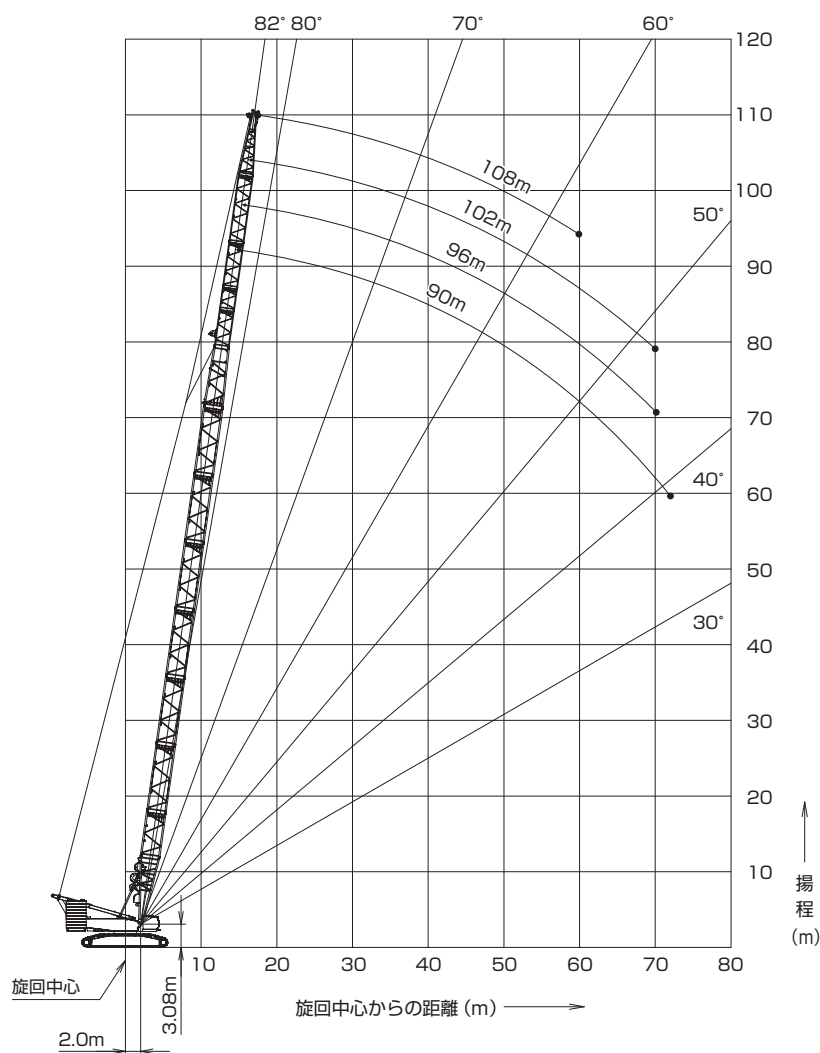

STANDARD

▶ ヘビーブーム定格総荷重表 (ダブルドラム仕様)

(単位: t)

ブーム長さ 作業半径(m)	21.0	24.0	30.0	36.0	42.0	48.0	54.0	60.0	66.0	72.0	78.0	84.0	ブーム長さ 作業半径(m)
6.0	500.0/6.2m	450.0/6.7m											6.0
7.0	447.1	447.1	417.3/7.5m										7.0
8.0	391.2	391.2	391.2	370.0/8.3m									8.0
9.0	347.7	347.7	347.7	347.7	333.8/9.2m								9.0
10.0	307.0	307.0	307.0	306.0	305.0	291.6	254.8/10.9m	224.8/11.7m					10.0
12.0	243.7	246.0	246.8	246.0	245.0	240.4	230.0	220.4	198.6/12.5m	176.4/13.4m			12.0
14.0	199.3	201.5	202.5	202.5	201.7	200.5	193.6	186.2	179.1	172.3	157.1/14.2m	139.7/15.0m	14.0
16.0	167.2	169.5	170.7	170.7	169.9	168.7	166.5	160.5	154.7	149.2	143.7	136.8	16.0
18.0	142.8	144.4	144.2	144.3	144.0	143.1	142.9	140.5	135.5	130.9	126.2	121.8	18.0
20.0	123.3/20.0m	124.0	123.8	123.9	123.4	122.6	122.3	121.2	120.1	116.1	112.0	108.1	20.0
22.0		108.3/22.0m	108.0	108.0	107.5	106.6	106.3	105.2	104.9	103.8	100.2	96.8	22.0
24.0			95.5	95.4	94.9	93.9	93.6	92.5	92.1	91.1	90.0	87.1	24.0
26.0			85.3	85.1	84.5	83.6	83.2	82.1	81.7	80.7	79.5	78.9	26.0
28.0			76.8	76.6	76.0	75.0	74.6	73.4	73.0	72.0	70.8	70.6	28.0
30.0			74.6/28.6m	69.4	68.7	67.7	67.3	66.1	65.7	64.6	63.5	63.2	30.0
32.0				63.3	62.6	61.5	61.0	59.9	59.4	58.4	57.2	56.9	32.0
34.0				58.5/33.8m	57.3	56.2	55.7	54.5	54.0	52.9	51.7	51.4	34.0
36.0					52.6	51.5	51.0	49.8	49.2	48.2	47.0	46.6	36.0
38.0					48.6	47.5	46.9	45.7	45.1	44.0	42.8	42.4	38.0
40.0					46.8/39.0m	43.9	43.2	42.0	41.4	40.3	39.1	38.7	40.0
44.0						37.8	37.1	35.8	35.1	34.1	32.8	32.4	44.0
48.0						37.6/44.2m	32.1	30.8	30.1	29.0	27.7	27.2	48.0
52.0							30.6/49.4m	26.7	25.9	24.8	23.5	23.0	52.0
56.0								24.5/54.6m	22.4	21.3	19.6	18.8	56.0
60.0									19.3/59.8m	18.0	16.1	15.2/60.0m	60.0
64.0										15.0	13.1/64.0m		64.0
68.0										14.4/65.0m			68.0
最大ブーム角度	82.0°	81.9°	82.0°	82.0°	81.9°	82.0°	81.9°	82.0°	82.0°	81.9°	82.0°	82.0°	最大ブーム角度
最小ブーム角度	34.8°	36.8°	30.2°	30.1°	30.1°	30.1°	30.1°	30.0°	30.0°	30.0°	38.3°	47.2°	最小ブーム角度
標準掛数	44	36	36	28	24	24	20	20	16	16	12	12	標準掛数

※ダブルドラムを使用する必要があります。

STANDARD

▶ メインブーム (ラフティング上部) 定格総荷重表 (ダブルドラム仕様)

(単位:t)

ブーム長さ 作業半径(m)	30.0	36.0	42.0	48.0	54.0	60.0	66.0	72.0	78.0	84.0	ブーム長さ 作業半径(m)
7.0	300.0/7.7m										7.0
8.0	300.0	300.0/8.5m									8.0
9.0	300.0	300.0	300.0/9.3m								9.0
10.0	300.0	300.0	300.0	280.0/10.2m	248.5/11.0m	220.0/11.8m					10.0
12.0	244.1	243.6	242.7	238.1	227.8	218.2	196.6/12.7m	164.0/13.5m			12.0
14.0	200.6	200.0	199.2	198.3	191.3	184.0	176.8	164.0	155.5/14.3m	138.6/15.2m	14.0
16.0	168.9	168.7	167.8	166.9	164.2	158.2	152.4	146.9	141.5	136.3	16.0
18.0	143.1	142.7	142.0	141.8	141.0	138.1	133.2	128.6	124.0	119.6	18.0
20.0	122.7	122.3	121.5	121.2	120.4	120.0	117.8	113.8	109.7	105.9	20.0
22.0	106.9	106.4	105.6	105.2	104.4	104.0	103.0	101.5	97.9	94.5	22.0
24.0	94.3	93.8	93.0	92.5	91.7	91.2	90.2	90.0	88.0	84.8	24.0
26.0	84.0	83.5	82.6	82.2	81.3	80.8	79.8	79.5	78.5	76.6	26.0
28.0	75.4	74.9	74.1	73.5	72.6	72.1	71.1	70.8	69.7	68.7	28.0
30.0	72.8/28.7m	67.7	66.8	66.3	65.4	64.8	63.7	63.5	62.4	61.3	30.0
32.0		61.6	60.7	60.1	59.1	58.6	57.5	57.2	56.1	55.0	32.0
34.0		56.6/33.9m	55.3	54.7	53.7	53.2	52.1	51.7	50.6	49.5	34.0
36.0			50.7	50.0	49.1	48.4	47.3	47.0	45.8	44.7	36.0
38.0			46.7	45.9	44.9	44.3	43.2	42.8	41.6	40.5	38.0
40.0			44.7/39.1m	42.3	41.3	40.6	39.5	39.1	37.9	36.8	40.0
44.0				36.2	35.1	34.4	33.2	32.8	31.6	30.4	44.0
48.0				35.8/44.3m	30.2	29.3	28.1	27.6	26.5	25.3	48.0
52.0					28.6/49.5m	25.2	24.0	23.4	22.0	20.4	52.0
56.0						22.4/54.7m	20.3	19.4	17.8	16.1	56.0
60.0							16.6/59.9m	15.8	14.2	12.5	60.0
64.0								12.5	11.1	11.0/62.0m	64.0
68.0								11.7/65.1m	9.8/66.0m		68.0
最大ブーム角度	81.9°	82.0°	82.0°	82.0°	82.0°	82.0°	82.0°	82.0°	82.0°	82.0°	最大ブーム角度
最小ブーム角度	30.1°	30.1°	30.1°	30.0°	30.0°	30.0°	30.0°	30.0°	36.0°	45.4°	最小ブーム角度
標準掛数	24	24	24	20	20	16	16	12	12	12	標準掛数

▶ メインブーム (ラフティング上部) 定格総荷重表 (シングルドラム仕様)

(単位:t)

ブーム長さ 作業半径(m)	30.0	36.0	42.0	48.0	54.0	60.0	66.0	72.0	78.0	84.0	ブーム長さ 作業半径(m)
7.0	200.0/7.7m										7.0
8.0	200.0	200.0/8.5m									8.0
9.0	200.0	200.0	200.0/9.3m								9.0
10.0	200.0	200.0	200.0	192.0/10.2m	174.0/11.0m	164.0/11.8m					10.0
12.0	200.0	200.0	200.0	192.0	174.0	164.0	152.0/12.7m	140.0/13.5m			12.0
14.0	200.0	200.0	199.2	192.0	174.0	164.0	152.0	140.0	126.0/14.3m	112.0/15.2m	14.0
16.0	168.9	168.7	167.8	166.9	164.2	158.2	152.0	140.0	126.0	112.0	16.0
18.0	143.1	142.7	142.0	141.8	141.0	138.1	133.2	128.6	124.0	112.0	18.0
20.0	122.7	122.3	121.5	121.2	120.4	120.0	117.8	113.8	109.7	105.9	20.0
22.0	106.9	106.4	105.6	105.2	104.4	104.0	103.0	101.5	97.9	94.5	22.0
24.0	94.3	93.8	93.0	92.5	91.7	91.2	90.2	90.0	88.0	84.8	24.0
26.0	84.0	83.5	82.6	82.2	81.3	80.8	79.8	79.5	78.5	76.6	26.0
28.0	75.4	74.9	74.1	73.5	72.6	72.1	71.1	70.8	69.7	68.7	28.0
30.0	72.8/28.7m	67.7	66.8	66.3	65.4	64.8	63.7	63.5	62.4	61.3	30.0
32.0		61.6	60.7	60.1	59.1	58.6	57.5	57.2	56.1	55.0	32.0
34.0		56.6/33.9m	55.3	54.7	53.7	53.2	52.1	51.7	50.6	49.5	34.0
36.0			50.7	50.0	49.1	48.4	47.3	47.0	45.8	44.7	36.0
38.0			46.7	45.9	44.9	44.3	43.2	42.8	41.6	40.5	38.0
40.0			44.7/39.1m	42.3	41.3	40.6	39.5	39.1	37.9	36.8	40.0
44.0				36.2	35.1	34.4	33.2	32.8	31.6	30.4	44.0
48.0				35.8/44.3m	30.2	29.3	28.1	27.6	26.5	25.3	48.0
52.0					28.6/49.5m	25.2	24.0	23.4	22.0	20.4	52.0
56.0						22.4/54.7m	20.3	19.4	17.8	16.1	56.0
60.0							16.6/59.9m	15.8	14.2	12.5	60.0
64.0								12.5	11.1	11.0/62.0m	64.0
68.0								11.7/65.1m	9.8/66.0m		68.0
最大ブーム角度	81.9°	82.0°	82.0°	82.0°	82.0°	82.0°	82.0°	82.0°	82.0°	82.0°	最大ブーム角度
最小ブーム角度	30.1°	30.1°	30.1°	30.0°	30.0°	30.0°	30.0°	30.0°	36.0°	45.4°	最小ブーム角度
標準掛数	16	16	16	15	13	12	11	10	9	8	標準掛数

▶ メインブーム（ラフティング上部）補助シーブ定格総荷重表（主ブームにフックなし /2 本掛け）

（単位：t）

ブーム長さ 作業半径(m)	48.0	54.0	60.0	66.0	72.0	78.0	84.0	ブーム長さ 作業半径(m)
10.0	28.0/11.3m							10.0
12.0	28.0	28.0/12.1m	28.0/12.9m	28.0/13.8m				12.0
14.0	28.0	28.0	28.0	28.0	28.0/14.6m	28.0/15.4m		14.0
16.0	28.0	28.0	28.0	28.0	28.0	28.0	28.0/16.3m	16.0
18.0	28.0	28.0	28.0	28.0	28.0	28.0	28.0	18.0
20.0	28.0	28.0	28.0	28.0	28.0	28.0	28.0	20.0
22.0	28.0	28.0	28.0	28.0	28.0	28.0	28.0	22.0
24.0	28.0	28.0	28.0	28.0	28.0	28.0	28.0	24.0
26.0	28.0	28.0	28.0	28.0	28.0	28.0	28.0	26.0
28.0	28.0	28.0	28.0	28.0	28.0	28.0	28.0	28.0
30.0	28.0	28.0	28.0	28.0	28.0	28.0	28.0	30.0
32.0	28.0	28.0	28.0	28.0	28.0	28.0	28.0	32.0
34.0	28.0	28.0	28.0	28.0	28.0	28.0	28.0	34.0
36.0	28.0	28.0	28.0	28.0	28.0	28.0	28.0	36.0
38.0	28.0	28.0	28.0	28.0	28.0	28.0	28.0	38.0
40.0	28.0	28.0	28.0	28.0	28.0	28.0	28.0	40.0
44.0	28.0	28.0	28.0	28.0	28.0	28.0	28.0	44.0
48.0	28.0/44.3m	28.0	28.0	27.4	26.9	25.8	24.6	48.0
52.0		27.9/49.5m	24.5	23.3	22.7	21.3	19.7	52.0
56.0			21.7/54.7m	19.6	18.7	17.1	15.4	56.0
60.0				15.9/59.9m	15.1	13.5	11.8	60.0
64.0					11.8	10.4	10.3/62.0m	64.0
68.0					11.0/65.1m	9.1/66.0m		68.0
最大ブーム角度	82.0°	82.0°	82.0°	82.0°	82.0°	82.0°	82.0°	最大ブーム角度
最小ブーム角度	36.0°	35.3°	34.8°	34.4°	34.0°	39.1°	47.7°	最小ブーム角度
標準掛数	2	2	2	2	2	2	2	標準掛数

▶ メインブーム（ラフティング上部）補助シーブ定格総荷重表（主ブームにフックなし /1 本掛け）

（単位：t）

ブーム長さ 作業半径(m)	48.0	54.0	60.0	66.0	72.0	78.0	84.0	ブーム長さ 作業半径(m)
10.0	14.0/11.6m							10.0
12.0	14.0	14.0/12.4m	14.0/13.2m					12.0
14.0	14.0	14.0	14.0	14.0/14.1m	14.0/14.9m	14.0/15.7m		14.0
16.0	14.0	14.0	14.0	14.0	14.0	14.0	14.0/16.6m	16.0
18.0	14.0	14.0	14.0	14.0	14.0	14.0	14.0	18.0
20.0	14.0	14.0	14.0	14.0	14.0	14.0	14.0	20.0
22.0	14.0	14.0	14.0	14.0	14.0	14.0	14.0	22.0
24.0	14.0	14.0	14.0	14.0	14.0	14.0	14.0	24.0
26.0	14.0	14.0	14.0	14.0	14.0	14.0	14.0	26.0
28.0	14.0	14.0	14.0	14.0	14.0	14.0	14.0	28.0
30.0	14.0	14.0	14.0	14.0	14.0	14.0	14.0	30.0
32.0	14.0	14.0	14.0	14.0	14.0	14.0	14.0	32.0
34.0	14.0	14.0	14.0	14.0	14.0	14.0	14.0	34.0
36.0	14.0	14.0	14.0	14.0	14.0	14.0	14.0	36.0
38.0	14.0	14.0	14.0	14.0	14.0	14.0	14.0	38.0
40.0	14.0	14.0	14.0	14.0	14.0	14.0	14.0	40.0
44.0	14.0	14.0	14.0	14.0	14.0	14.0	14.0	44.0
48.0	14.0/44.3m	14.0	14.0	14.0	14.0	14.0	14.0	48.0
52.0		14.0/49.5m	14.0	14.0	14.0	14.0	14.0	52.0
56.0			14.0/54.7m	14.0	14.0	14.0	14.0	56.0
60.0				14.0/59.9m	14.0	13.5	11.8	60.0
64.0					11.8	10.4	10.3/62.0m	64.0
68.0					11.0/65.1m	9.1/66.0m		68.0
最大ブーム角度	82.0°	82.0°	82.0°	82.0°	82.0°	82.0°	82.0°	最大ブーム角度
最小ブーム角度	36.6°	35.9°	35.3°	34.9°	34.5°	39.4°	47.9°	最小ブーム角度
標準掛数	1	1	1	1	1	1	1	標準掛数

STANDARD

▶ ロングブーム定格総荷重表 (シングルドラム仕様)

(単位: t)

ブーム長さ (m) 作業半径(m)	90.0	96.0	102.0	108.0	ブーム長さ (m) 作業半径(m)
14.0	98.0/15.0m	84.0/15.9m			14.0
16.0	97.0	83.7	70.0/16.6m	70.0/17.5m	16.0
18.0	94.0	82.0	69.0	69.0	18.0
20.0	91.0	80.0	67.0	66.0	20.0
22.0	87.7	78.0	65.0	63.0	22.0
24.0	80.4	76.0	63.0	60.0	24.0
26.0	74.2	74.0	61.0	57.0	26.0
28.0	68.9	68.9	59.0	54.0	28.0
30.0	62.6	64.3	56.9	51.0	30.0
32.0	56.7	59.7	54.8	48.0	32.0
34.0	51.5	54.9	52.7	45.0	34.0
36.0	46.9	50.1	48.6	41.0	36.0
38.0	42.8	45.9	45.0	37.1	38.0
40.0	39.1	42.1	41.3	33.6	40.0
44.0	32.8	35.7	34.6	27.6	44.0
48.0	27.6	30.5	29.1	22.7	48.0
52.0	23.1	26.0	24.5	18.6	52.0
56.0	19.3	22.0	20.5	15.0	56.0
60.0	16.0	18.5	17.1	11.9/60.0m	60.0
64.0	13.1	15.5	14.1		64.0
68.0	10.4	12.9	11.4		68.0
72.0	8.1/72.0m	11.7/70.0m	10.2/70.0m		72.0
最大ブーム角度	82.0°	82.0°	82.0°	82.0°	最大ブーム角度
最小ブーム角度	39.2°	45.2°	48.4°	57.7°	最小ブーム角度
標準掛数	7	6	5	5	標準掛数

▶ ロング補助シーブ定格総荷重表 (主ブームにフックなし / 2本掛け)

(単位: t)

ジブ長さ (m) 作業半径(m)	90.0	96.0	102.0	ジブ長さ (m) 作業半径(m)
14.0	28.0/15.9m			14.0
16.0	28.0	28.0/16.7m	28.0/17.5m	16.0
18.0	28.0	28.0	28.0	18.0
20.0	28.0	28.0	28.0	20.0
22.0	28.0	28.0	28.0	22.0
24.0	28.0	28.0	28.0	24.0
26.0	28.0	28.0	28.0	26.0
28.0	28.0	28.0	28.0	28.0
30.0	28.0	28.0	28.0	30.0
32.0	28.0	28.0	28.0	32.0
34.0	28.0	28.0	28.0	34.0
36.0	28.0	28.0	28.0	36.0
38.0	28.0	28.0	28.0	38.0
40.0	28.0	28.0	28.0	40.0
44.0	28.0	28.0	28.0	44.0
48.0	26.9	28.0	28.0	48.0
52.0	22.4	25.3	23.8	52.0
56.0	18.6	21.3	19.8	56.0
60.0	15.3	17.8	16.4	60.0
64.0	12.4	14.8	13.4	64.0
68.0	9.7	12.2	10.7	68.0
72.0	7.4/72.0m	11.0/70.0m	9.5/70.0m	72.0
最大ジブ角度	82.0°	82.0°	82.0°	最大ジブ角度
最小ジブ角度	40.9°	46.5°	49.6°	最小ジブ角度
標準掛数	2	2	2	標準掛数

▶ ロング補助シーブ定格総荷重表 (主ブームにフックなし / 1 本掛け)

(単位 : t)

ブーム長さ (m) 作業半径(m)	90.0	96.0	102.0	ブーム長さ (m) 作業半径(m)
16.0	14.0/16.2m	14.0/17.0m	14.0/17.8m	16.0
18.0	14.0	14.0	14.0	18.0
20.0	14.0	14.0	14.0	20.0
22.0	14.0	14.0	14.0	22.0
24.0	14.0	14.0	14.0	24.0
26.0	14.0	14.0	14.0	26.0
28.0	14.0	14.0	14.0	28.0
30.0	14.0	14.0	14.0	30.0
32.0	14.0	14.0	14.0	32.0
34.0	14.0	14.0	14.0	34.0
36.0	14.0	14.0	14.0	36.0
38.0	14.0	14.0	14.0	38.0
40.0	14.0	14.0	14.0	40.0
44.0	14.0	14.0	14.0	44.0
48.0	14.0	14.0	14.0	48.0
52.0	14.0	14.0	14.0	52.0
56.0	14.0	14.0	14.0	56.0
60.0	14.0	14.0	14.0	60.0
64.0	12.4	14.0	13.4	64.0
68.0	9.7	12.2	10.7	68.0
72.0	7.4/72.0m	11.0/70.0m	9.5/70.0m	72.0
最大ブーム角度	82.0°	82.0°	82.0°	最大ブーム角度
最小ブーム角度	41.2°	46.8°	49.9°	最小ブーム角度
標準掛数	1	1	1	標準掛数

STANDARD

▶ ラフティングジブ作動範囲図

■ ラフティングジブ (ブーム角度 86°)

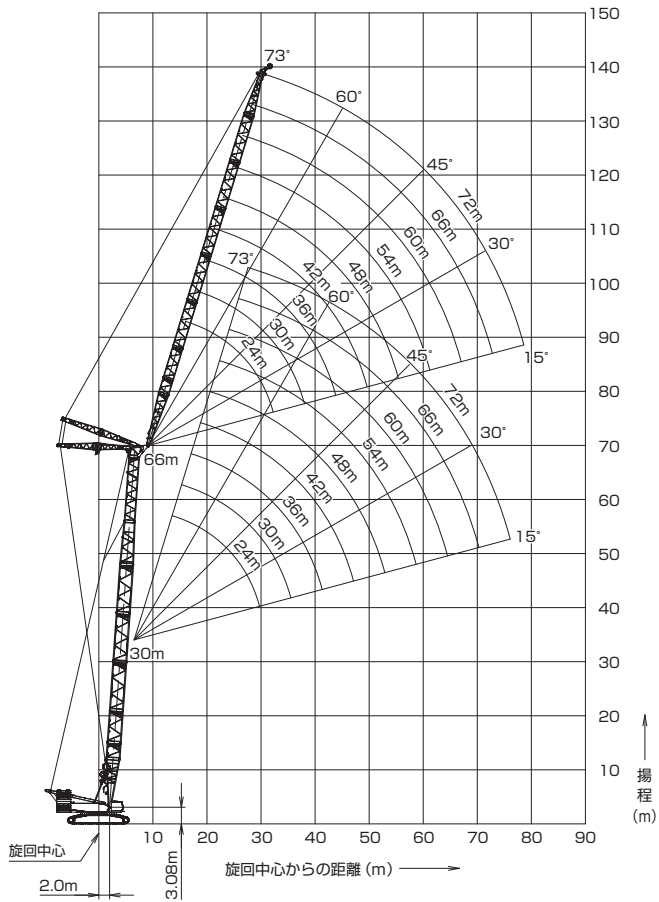

■ ラフティングジブ (ブーム角度 76°)

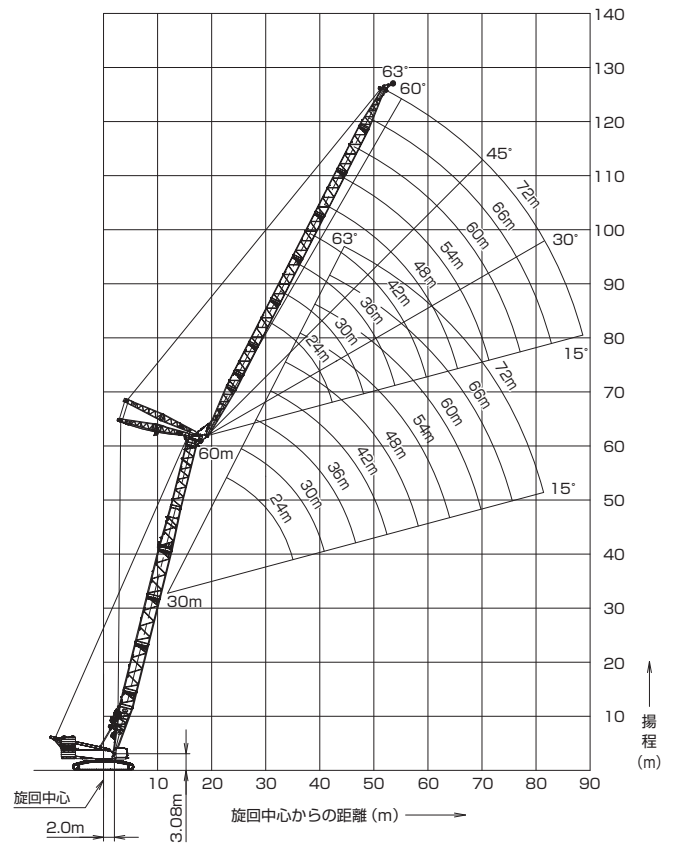

■ ラフティングジブ (ブーム角度 66°)

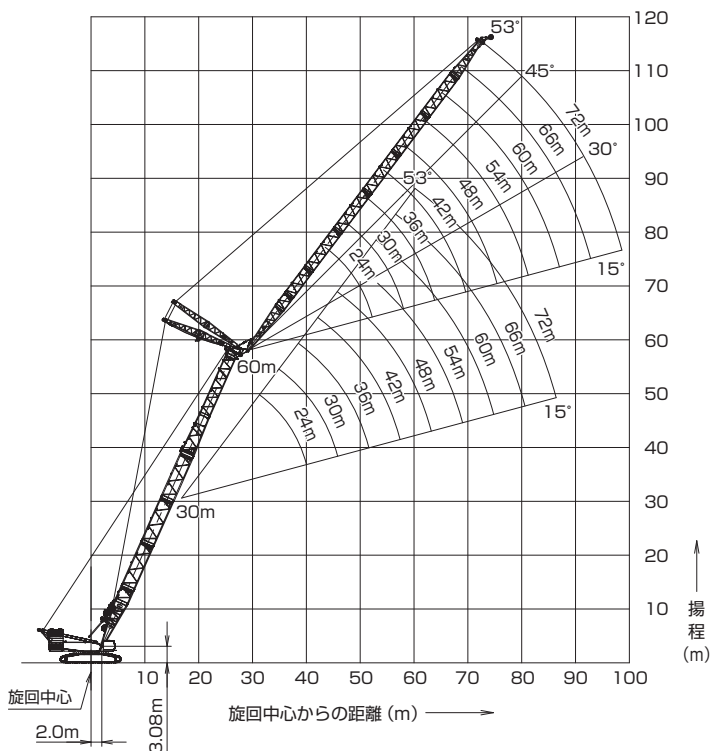

STANDARD

▶ ラフティングジブ定格総荷重表 (ダブルドラム仕様)

(単位:t)

ブーム長さ(m)		30.0															ブーム長さ(m)
ジブ長さ(m)		24.0			30.0			36.0			42.0			48.0			ジブ長さ(m)
ブーム角度		86°	76°	66°	86°	76°	66°	86°	76°	66°	86°	76°	66°	86°	76°	66°	ブーム角度
作業半径(m)	14.0	195.1/14.0m															14.0
	15.0	182.0															15.0
	16.0	170.7			164.0/16.0m												16.0
	17.0	160.6			160.6												17.0
	18.0	151.7			151.7			148.2/18.0m									18.0
	20.0	134.3			134.3			133.2			112.0/20.0m						20.0
	22.0	119.1			119.1			118.4			112.0			112.0/22.0m			22.0
	24.0	106.3	99.6/24.0m		106.3			105.6			105.6			104.3			24.0
	26.0	95.8	89.8		95.8	89.5/26.0m		95.1			95.1			94.4			26.0
	28.0	85.8/28.0m	81.6		87.1	81.4		86.4			86.4			85.7			28.0
	30.0		74.7		79.7	74.4		79.1	73.6/30.0m		79.1			78.4			30.0
	34.0		63.6/34.0m	59.4/34.0m	66.6/34.0m	63.4		67.4	62.6		67.3	62.5/34.0m		66.6			34.0
	38.0			51.5/38.0m		55.0/38.0m	51.2/38.0m	58.5/38.0m	54.2		58.4	54.1		57.7	53.2/38.0m		38.0
	42.0						44.9/42.0m		47.7	44.1/42.0m	51.3	47.5		50.6	46.7		42.0
	46.0								42.4/46.0m	39.1	45.6/46.0m	42.1	38.8/46.0m	44.9	41.3		46.0
	50.0									35.1/50.0m		37.7/50.0m	34.7	40.3/50.0m	37.0	33.5/50.0m	50.0
	54.0												31.3/54.0m		33.3	30.0	54.0
58.0														30.2/58.0m	27.1	58.0	
62.0															24.5/62.0m	62.0	
最大ジブ角度		72.9°	60.6°	45.4°	72.4°	62.7°	46.0°	72.1°	60.4°	46.4°	71.9°	58.8°	46.6°	71.7°	57.5°	46.8°	最大ジブ角度
最小ジブ角度		27.6°	23.7°	29.3°	24.6°	30.2°	33.9°	29.8°	19.1°	23.7°	20.6°	25.3°	28.4°	25.6°	16.5°	20.4°	最小ジブ角度
標準掛数		16			12			12			8			8			標準掛数

※上表の場合、補助シーブ吊りはできません。

(単位:t)

ブーム長さ(m)		30.0											ブーム長さ(m)		
ジブ長さ(m)		54.0			60.0			66.0			72.0		ジブ長さ(m)		
ブーム角度		86°	76°	66°	86°	76°	66°	86°	76°	66°	86°	76°	66°	ブーム角度	
作業半径(m)	24.0	100.2/24.0m												24.0	
	26.0	93.8			89.3/26.0m									26.0	
	28.0	85.1			84.3			79.9/28.0m						28.0	
	30.0	77.7			77.0			76.2			63.3/30.0m			30.0	
	34.0	66.0			65.3			64.5			58.7			34.0	
	38.0	57.1	52.5/38.0m		56.3			55.5			51.8			38.0	
	42.0	50.0	46.0		49.3	45.1/42.0m		48.5			46.5			42.0	
	46.0	44.3	40.6		43.6	39.8		42.8	38.6/46.0m		42.1	37.6/46.0m		46.0	
	50.0	39.6	36.3	32.5/50.0m	38.9	35.4		38.1	34.2		37.4	33.1		50.0	
	54.0	35.7	32.6	29.0	35.0	31.6	27.7/54.0m	34.2	30.4		33.5	29.3		54.0	
	58.0	32.5/58.0m	29.5	26.0	31.7	28.4	24.8	30.9	27.2	23.5/58.0m	30.0	26.1		58.0	
	62.0		26.9/62.0m	23.5	28.9/62.0m	25.6	22.2	28.0	24.4	20.9	27.0	23.4	19.8/62.0m	62.0	
	66.0			21.3/66.0m		23.3/66.0m	20.0	25.5	22.0	18.7	24.4	21.0	17.6	66.0	
	70.0						18.1	22.9/70.0m	20.0	16.8	21.1	18.9	15.7	70.0	
	74.0							16.5/74.0m		18.2/74.0m	15.2	18.3/74.0m	17.1	14.1	74.0
	78.0										13.7/78.0m		15.5/78.0m	12.6	78.0
	82.0													11.3	82.0
86.0													10.2/86.0m	86.0	
最大ジブ角度		71.6°	61.5°	52.6°	71.5°	60.2°	52.2°	71.4°	59.2°	51.8°	71.3°	62.0°	51.5°	最大ジブ角度	
最小ジブ角度		18.1°	22.2°	24.9°	22.8°	25.9°	18.2°	16.3°	20.0°	22.5°	20.8°	23.6°	16.5°	最小ジブ角度	
標準掛数		8			8			8			8			標準掛数	

※上表の場合、補助シーブ吊りはできません。

(単位：t)

ブーム長さ(m)		36.0														ブーム長さ(m)		
ジブ長さ(m)		24.0			30.0			36.0			42.0			48.0			ジブ長さ(m)	
ブーム角度		86°	76°	66°	86°	76°	66°	86°	76°	66°	86°	76°	66°	86°	76°	66°	ブーム角度	
作業半径(m)	15.0	182.0/15.0m															15.0	
	16.0	170.7															16.0	
	17.0	160.6			156.6/17.0m												17.0	
	18.0	151.2			148.5			143.1/18.0m									18.0	
	20.0	133.1			133.2			129.4					112.0/20.0m				20.0	
	22.0	118.5			118.5			117.5					112.0		109.6/22.0m		22.0	
	24.0	105.7			105.8			105.1					104.2		102.1		24.0	
	26.0	95.3	87.9/26.0m		95.3			94.7					94.7		94.0		26.0	
	28.0	86.6	79.8		86.6	79.6/28.0m		86.0					86.0		85.3		28.0	
	30.0	78.4/30.0m	73.0		79.3	72.8		78.7					78.7		78.0		30.0	
	34.0		62.2/34.0m		67.6/34.0m	62.0		67.0	61.1/34.0m				67.0	61.0/34.0m	66.3		34.0	
	38.0			49.3/38.0m		53.7	48.9/38.0m	58.1/38.0m	52.9				58.1	52.8		57.3	51.9/38.0m	38.0
	42.0			43.3/42.0m		47.2/42.0m	42.9		46.4	41.6/42.0m			51.0	46.3		50.3	45.5	42.0
	46.0						38.1/46.0m		41.2/46.0m	36.8	45.3/46.0m		41.1	36.5/46.0m	44.6	40.2		46.0
	50.0									32.9		36.8/50.0m		32.5	40.0/50.0m	35.9	31.2/50.0m	50.0
	54.0									29.6/54.0m				29.1		32.4	27.8	54.0
	58.0													26.3/58.0m		29.3/58.0m	25.0	58.0
62.0																22.6/62.0m	62.0	
最大ジブ角度	71.5°	59.1°	39.8°	71.3°	61.5°	52.3°	72.8°	55.6°	51.6°	72.5°	61.1°	51.1°	72.3°	59.5°	50.7°		最大ジブ角度	
最小ジブ角度	17.3°	31.4°	20.0°	26.5°	17.8°	27.9°	31.1°	25.4°	16.1°	22.2°	29.7°	23.4°	26.8°	21.9°	27.7°		最小ジブ角度	
標準掛数	16			12			12			8			8			標準掛数		

※上表の場合、補助シーブ吊りはできません。

(単位：t)

ブーム長さ(m)		36.0											ブーム長さ(m)	
ジブ長さ(m)		54.0			60.0			66.0			72.0		ジブ長さ(m)	
ブーム角度		86°	76°	66°	86°	76°	66°	86°	76°	66°	86°	76°	66°	ブーム角度
作業半径(m)	24.0	97.1/24.0m												24.0
	26.0	91.3			86.6/26.0m									26.0
	28.0	84.6			82.2			77.4/28.0m						28.0
	30.0	77.3			76.4			74.1			64.0/30.0m			30.0
	34.0	65.6			64.9			64.1			57.3			34.0
	38.0	56.7			56.0			55.2			51.7			38.0
	42.0	49.7	44.7/42.0m		48.9	43.5/42.0m		48.2			46.9			42.0
	46.0	44.0	39.5		43.3	38.2		42.5	37.0/46.0m		41.8			46.0
	50.0	39.4	35.1		38.6	33.9		37.8	32.6		37.1	31.5/50.0m		50.0
	54.0	35.5	31.4	26.7/54.0m	34.7	30.2		33.9	28.9		33.0	27.9		54.0
	58.0	32.2/58.0m	28.3	23.9	31.4	27.0	22.6/58.0m	30.5	25.8		29.5	24.7		58.0
	62.0		25.6/62.0m	21.5	28.6/62.0m	24.4	20.2	27.6	23.1	18.9/62.0m	26.5	22.1		62.0
	66.0			19.4		22.0	18.1	25.0	20.8	16.8	24.0	19.7	15.7/66.0m	66.0
	70.0			17.6/70.0m		20.1/70.0m	16.3	22.8/70.0m	18.8	15.0	21.0	17.7	13.8	70.0
	74.0						14.7/74.0m		17.0/74.0m	13.4	18.1/74.0m	15.9	12.3	74.0
78.0									12.0		14.4	10.9	78.0	
82.0									10.8/82.0m		12.0/82.0m	9.6	82.0	
86.0												8.6/86.0m	86.0	
最大ジブ角度	72.1°	58.4°	50.5°	71.9°	61.8°	50.2°	71.8°	60.7°	50.1°	71.7°	59.7°	49.9°		最大ジブ角度
最小ジブ角度	19.5°	26.1°	20.6°	23.9°	19.5°	24.7°	17.6°	23.5°	18.6°	21.7°	17.8°	22.5°		最小ジブ角度
標準掛数	8			8			8			8		標準掛数		

※上表の場合、補助シーブ吊りはできません。

(単位:t)

ブーム長さ(m)		42.0														ブーム長さ(m)	
ジブ長さ(m)		24.0			30.0			36.0			42.0			48.0			ジブ長さ(m)
ブーム角度		86°	76°	66°	86°	76°	66°	86°	76°	66°	86°	76°	66°	86°	76°	66°	ブーム角度
作業半径(m)	15.0	172.7/15.4m															15.0
	16.0	166.0															16.0
	17.0	156.2			151.0/17.0m												17.0
	18.0	148.2			143.4												18.0
	20.0	131.6			129.0			125.2/20.0m									20.0
	22.0	117.3			117.2			113.8				109.3/22.0m			106.0/22.0m		22.0
	24.0	105.2			105.2			104.1				101.9			99.0		24.0
	26.0	94.7			94.8			94.1				94.0			91.3		26.0
	28.0	86.1	77.5/28.0m		86.2			85.5				85.6			84.6		28.0
	30.0	78.7/30.0m	71.2		78.9	70.9/30.0m		78.2				78.3			77.6		30.0
	34.0		60.6		67.2/34.0m	60.4		66.5	59.4/34.0m			66.6			65.9		34.0
	38.0		52.4/38.0m	46.0/38.0m		52.3		57.7	51.5			57.7	51.4/38.0m		57.0	50.1/38.0m	38.0
	42.0			40.3/42.0m		45.9/42.0m	39.8/42.0m	50.7/42.0m	45.1			50.7	45.0		50.0	43.8	42.0
	46.0						35.2		40.0/46.0m	33.9/46.0m		45.0/46.0m	39.9		44.3	38.7	46.0
	50.0						31.4/50.0m			30.2		35.6	29.9/50.0m	39.7/50.0m	34.4		50.0
	54.0											32.0/54.0m	26.7		30.8	25.3/54.0m	54.0
58.0												24.0		27.8/58.0m	22.7	58.0	
62.0													21.6/62.0m		20.3	62.0	
66.0															18.4/66.0m	66.0	
最大ジブ角度		71.5°	57.5°	48.4°	72.1°	60.3°	48.3°	70.2°	58.4°	48.3°	70.2°	57.0°	48.3°	72.8°	61.5°	48.3°	最大ジブ角度
最小ジブ角度		20.6°	15.4°	33.4°	28.3°	25.6°	20.4°	16.6°	30.5°	27.0°	23.7°	21.4°	17.1°	27.9°	26.2°	23.3°	最小ジブ角度
標準掛数		12			12			8			8			8			標準掛数

※上表の場合、補助シーブ吊りはできません。

(単位:t)

ブーム長さ(m)		42.0											ブーム長さ(m)	
ジブ長さ(m)		54.0			60.0			66.0			72.0			ジブ長さ(m)
ブーム角度		86°	76°	66°	86°	76°	66°	86°	76°	66°	86°	76°	66°	ブーム角度
作業半径(m)	24.0	94.0/24.0m												24.0
	26.0	88.6			83.8/26.0m									26.0
	28.0	82.1			79.8			74.9/28.0m						28.0
	30.0	76.4			74.2			72.0			64.8/30.0m			30.0
	34.0	65.2			64.5			62.8			58.0			34.0
	38.0	56.3			55.6			54.8			52.3			38.0
	42.0	49.3	42.7/42.0m		48.6			47.8			47.0			42.0
	46.0	43.7	37.6		42.9	36.3/46.0m		42.1	35.0/46.0m		41.2			46.0
	50.0	39.0	33.4		38.3	32.1		37.4	30.8		36.4	29.7/50.0m		50.0
	54.0	35.2	29.8		34.4	28.5		33.4	27.3		32.4	26.2		54.0
	58.0	31.9/58.0m	26.7	21.5/58.0m	31.1	25.5		29.9	24.2		28.9	23.2		58.0
	62.0		24.1	19.2	28.2/62.0m	22.9	17.9/62.0m	27.0	21.6	16.6/62.0m	26.0	20.6		62.0
	66.0		21.9/66.0m	17.3		20.7	15.9	24.5	19.4	14.6	23.4	18.3	13.5/66.0m	66.0
	70.0			15.5		18.7/70.0m	14.2	22.3/70.0m	17.4	12.9	20.8	16.3	11.8	70.0
	74.0			14.1/74.0m			12.7		15.7	11.4	17.9/74.0m	14.6	10.3	74.0
	78.0						11.4/78.0m		14.3/78.0m	10.1		13.1	8.9	78.0
82.0									8.9/82.0m		11.8/82.0m	7.8	82.0	
86.0												6.8	86.0	
90.0												5.9/90.0m	90.0	
最大ジブ角度		72.5°	60.2°	48.3°	72.3°	59.0°	48.3°	72.2°	62.1°	52.8°	72.0°	61.0°	52.4°	最大ジブ角度
最小ジブ角度		20.8°	18.8°	15.0°	24.9°	23.4°	20.7°	18.8°	17.0°	24.4°	22.6°	21.3°	18.9°	最小ジブ角度
標準掛数		8			8			8			8			標準掛数

※上表の場合、補助シーブ吊りはできません。

(単位：t)

ブーム長さ(m)		48.0														ブーム長さ(m)	
ジブ長さ(m)		24.0			30.0			36.0			42.0			48.0			ジブ長さ(m)
ブーム角度		86°	76°	66°	86°	76°	66°	86°	76°	66°	86°	76°	66°	86°	76°	66°	ブーム角度
作業半径(m)	16.0	158.0/162m															16.0
	17.0	151.2			145.4/17.0m												17.0
	18.0	143.0			138.3												18.0
	20.0	128.8			124.7			121.0/20.0m									20.0
	22.0	115.8			113.4			110.1			105.7/22.0m						22.0
	24.0	104.2			103.9			101.8			98.8			93.8/24.0m			24.0
	26.0	94.2			94.3			93.6			91.2			88.6			26.0
	28.0	85.5	74.4/28.0m		85.7			85.0			84.5			82.1			28.0
	30.0	78.2/30.0m	68.3		78.4			77.7			77.8			76.5			30.0
	34.0		58.3		66.7/34.0m	58.1/34.0m		66.1	56.8/34.0m		66.2			65.5			34.0
	38.0		50.6/38.0m			50.4		57.2	49.1		57.3	49.1/38.0m		56.6			38.0
	42.0			37.0/42.0m		44.2/42.0m		50.3/42.0m	43.0		50.3	43.0		49.6	41.7/42.0m		42.0
	46.0			32.6/46.0m			32.2/46.0m		38.1		44.7/46.0m	38.0		44.0	36.7		46.0
	50.0						28.6/50.0m		34.0/50.0m	27.3/50.0m		33.8	27.1/50.0m	39.4	32.6		50.0
	54.0									24.3		30.3/54.0m	24.1	35.5/54.0m	29.1	22.7/54.0m	54.0
	58.0									21.9/58.0m			21.5		26.2	20.2	58.0
	62.0												19.3/62.0m		23.7/62.0m	18.0	62.0
66.0															16.1	66.0	
70.0															14.5/70.0m	70.0	
最大ジブ角度	70.5°	61.6°	43.1°	73.0°	54.4°	44.2°	70.9°	61.1°	44.9°	70.8°	59.3°	52.6°	70.8°	58.0°	52.1°	最大ジブ角度	
最小ジブ角度	23.4°	25.8°	25.6°	30.0°	31.5°	31.4°	18.9°	20.8°	20.7°	25.1°	26.4°	26.4°	16.2°	17.9°	17.8°	最小ジブ角度	
標準掛数	12			12			8			8			8			標準掛数	

※上表の場合、補助シーブ吊りはできません。

(単位：t)

ブーム長さ(m)		48.0											ブーム長さ(m)	
ジブ長さ(m)		54.0			60.0			66.0			72.0			ジブ長さ(m)
ブーム角度		86°	76°	66°	86°	76°	66°	86°	76°	66°	86°	76°	66°	ブーム角度
作業半径(m)	24.0	90.8/24.0m												24.0
	26.0	85.9			81.1/26.0m									26.0
	28.0	79.6			77.4			72.4/28.0m						28.0
	30.0	74.1			72.0			69.8			65.0/30.0m			30.0
	34.0	64.8			63.0			60.9			58.6			34.0
	38.0	56.0			55.2			53.8			52.1			38.0
	42.0	49.0	40.6/42.0m		48.2			47.2			46.1			42.0
	46.0	43.4	35.6		42.6	34.3/46.0m		41.4			40.4			46.0
	50.0	38.7	31.5		37.8	30.2		36.7	28.9/50.0m		35.7	27.4/50.0m		50.0
	54.0	34.9	28.1		33.8	26.8		32.7	25.5		31.7	24.4		54.0
	58.0	31.6/58.0m	25.1	19.0/58.0m	30.5	23.9		29.3	22.6		28.3	21.5		58.0
	62.0		22.6	16.9	27.6/62.0m	21.4	15.5/62.0m	26.4	20.1		25.4	19.0		62.0
	66.0		20.5/66.0m	15.0		19.2	13.7	23.9	17.9	12.3/66.0m	22.8	16.8		66.0
	70.0			13.4		17.3	12.1	20.6/70.0m	16.0	10.7	20.2	14.9	9.5/70.0m	70.0
74.0			12.0/74.0m		15.7/74.0m	10.7		14.4	9.3	17.4/74.0m	13.3	8.1	74.0	
78.0						9.4		13.0/78.0m	8.1		11.8	6.9/78.0m	78.0	
82.0						8.4/82.0m			7.0/82.0m		10.5/82.0m		82.0	
最大ジブ角度	73.0°	61.9°	51.7°	72.7°	60.6°	51.3°	72.5°	59.6°	51.1°	72.4°	62.3°	50.8°	最大ジブ角度	
最小ジブ角度	22.1°	23.2°	23.1°	25.8°	16.0°	15.9°	19.9°	20.9°	29.2°	23.5°	24.3°	42.0°	最小ジブ角度	
標準掛数	8			8			8			8			標準掛数	

※上表の場合、補助シーブ吊りはできません。

(単位:t)

ブーム長さ(m)		54.0															ブーム長さ(m)	
ジブ長さ(m)		24.0			30.0			36.0			42.0			48.0			ジブ長さ(m)	
ブーム角度		86°	76°	66°	86°	76°	66°	86°	76°	66°	86°	76°	66°	86°	76°	66°	ブーム角度	
作業半径(m)	17.0	145.7/17.0m															17.0	
	18.0	137.8			132.5/18.0m												18.0	
	20.0	124.3			120.4			115.8/20.0m									20.0	
	22.0	113.2			109.6			106.4				102.1/22.0m					22.0	
	24.0	102.8			101.5			98.6				95.6			90.6/24.0m		24.0	
	26.0	93.2			93.5			91.0				88.3			85.8		26.0	
	28.0	84.9			85.1			84.3				82.0			79.6		28.0	
	30.0	77.6/30.0m	65.3/30.0m		77.8			77.1				76.4			74.1		30.0	
	34.0		55.6		66.2/34.0m	55.5/34.0m		65.5				65.7			65.0		34.0	
	38.0		48.2/38.0m			48.0		56.7	46.7/38.0m			56.9	46.8/38.0m		56.2		38.0	
	42.0			33.6/42.0m		42.1		49.8/42.0m	40.8			49.9	40.8		49.2	39.5/42.0m	42.0	
	46.0			29.5/46.0m		37.2/46.0m	29.2/46.0m		36.0			44.3/46.0m	36.0		43.6	34.7	46.0	
	50.0						25.8		32.1/50.0m	24.4/50.0m			32.0		39.0	30.7	50.0	
	54.0						22.9/54.0m				21.6		28.6	21.4/54.0m	35.1/54.0m	27.4	54.0	
	58.0										19.3/58.0m		25.8/58.0m		19.0	24.5	17.6/58.0m	58.0
	62.0														17.0	22.1/62.0m	15.6	62.0
66.0													15.2/66.0m			13.8	66.0	
70.0																12.3/70.0m	70.0	
最大ジブ角度		69.6°	60.1°	51.2°	71.8°	57.8°	50.6°	71.6°	56.3°	50.2°	71.4°	61.6°	49.9°	71.3°	60.0°	49.7°	最大ジブ角度	
最小ジブ角度		25.9°	33.1°	37.2°	31.6°	20.0°	24.9°	20.9°	26.7°	30.0°	26.5°	16.7°	20.9°	18.0°	23.0°	25.9°	最小ジブ角度	
標準掛数		12			12			8			8			8			標準掛数	

※上表の場合、補助シーブ吊りはできません。

(単位:t)

ブーム長さ(m)		54.0										ブーム長さ(m)
ジブ長さ(m)		54.0			60.0			66.0		72.0		ジブ長さ(m)
ブーム角度		86°	76°	66°	86°	76°	66°	86°	76°	86°	76°	ブーム角度
作業半径(m)	26.0	80.8/26.0m										26.0
	28.0	77.1			72.3/28.0m			69.9/28.0m				28.0
	30.0	71.8			69.7			67.5		62.7/30.0m		30.0
	34.0	62.9			61.0			59.0		57.2		34.0
	38.0	55.5			54.0			52.1		50.4		38.0
	42.0	48.6			47.5			46.3		44.8		42.0
	46.0	43.0	33.6/46.0m		41.8	31.9/46.0m		40.7		39.7		46.0
	50.0	38.3	29.7		37.1	28.3		36.0	26.5/50.0m	35.0		50.0
	54.0	34.3	26.3		33.2	25.0		32.0	23.7	31.0	22.0/54.0m	54.0
	58.0	31.0/58.0m	23.5		29.8	22.2		28.6	20.9	27.6	19.8	58.0
	62.0		21.1	14.4/62.0m	27.0	19.8		25.8	18.5	24.7	17.4	62.0
	66.0		19.0/66.0m	12.7	23.2/66.0m	17.7	11.3/66.0m	23.3	16.4	22.2	15.3	66.0
	70.0			11.2		15.9	9.8	19.3/70.0m	14.6	19.4	13.5	70.0
	74.0			9.9		14.3/74.0m	8.5		13.0	16.7/74.0m	11.9	74.0
78.0			8.8/78.0m			7.4/78.0m		11.6/78.0m		10.5	78.0	
82.0										9.2	82.0	
86.0										8.2/86.0m	86.0	
最大ジブ角度		71.2°	58.8°	49.5°	71.2°	62.2°	49.4°	72.9°	61.0°	72.7°	60.0°	最大ジブ角度
最小ジブ角度		23.2°	26.9°	18.4°	16.0°	20.5°	31.5°	21.0°	24.3°	24.3°	18.7°	最小ジブ角度
標準掛数		8			8			8		8		標準掛数

※上表の場合、補助シーブ吊りはできません。

(単位：t)

ブーム長さ(m)		60.0														ブーム長さ(m)		
ジブ長さ(m)		24.0			30.0			36.0			42.0			48.0			ジブ長さ(m)	
ブーム角度		86°	76°	66°	86°	76°	66°	86°	76°	66°	86°	76°	66°	86°	76°	66°	ブーム角度	
作業半径(m)	17.0	131.2/17.8m															17.0	
	18.0	132.8			127.5/18.0m												18.0	
	20.0	120.0			116.2			111.7/20.0m									20.0	
	22.0	109.3			105.9			103.8				98.5/22.0m					22.0	
	24.0	101.3			98.2			95.4				92.5			87.5/24.0m		24.0	
	26.0	93.2			90.7			88.1				85.5			83.0		26.0	
	28.0	85.0			84.1			81.9				79.4			77.0		28.0	
	30.0	77.8/30.0m			77.2			76.1				74.0			71.8		30.0	
	34.0		53.9/34.0m		65.7/34.0m	52.6/34.0m		65.0				65.0			63.0		34.0	
	38.0		46.7			45.4		56.2	44.0/38.0m			56.5			55.6		38.0	
	42.0		40.8/42.0m			39.7		49.3/42.0m	38.4			49.5	38.5/42.0m		48.7	36.9/42.0m	42.0	
	46.0			27.2/46.0m		35.0/46.0m			33.8			43.9/46.0m	33.8		43.1	32.5	46.0	
	50.0			24.0/50.0m				22.6/50.0m	30.0/50.0m				30.0		38.5	28.7	50.0	
	54.0							20.0			18.6/54.0m		26.7		34.6/54.0m	25.5	54.0	
	58.0							17.8/58.0m			16.4		24.0/58.0m	16.2/58.0m		22.7	58.0	
	62.0										14.6/62.0m			14.3		20.4/62.0m	12.9/62.0m	62.0
	66.0													12.7/66.0m			11.3	66.0
70.0																9.9	70.0	
74.0																8.7/74.0m	74.0	
最大ジブ角度	68.6°	52.7°	46.1°	72.6°	61.1°	46.6°	72.3°	59.0°	46.8°	72.0°	57.6°	47.0°	71.8°	62.0°	47.2°	最大ジブ角度		
最小ジブ角度	28.1°	18.5°	30.3°	33.1°	27.1°	16.1°	22.7°	31.6°	24.5°	27.8°	22.8°	29.0°	19.6°	27.2°	21.1°	最小ジブ角度		
標準掛数		12			12			8			8			8		標準掛数		

※上表の場合、補助シーブ吊りはできません。

(単位：t)

ブーム長さ(m)		60.0								ブーム長さ(m)	
ジブ長さ(m)		54.0		60.0		66.0		72.0		ジブ長さ(m)	
ブーム角度		86°	76°	66°	86°	76°	86°	76°	86°	76°	ブーム角度
作業半径(m)	26.0	77.9/26.0m									26.0
	28.0	74.6			69.8/28.0m						28.0
	30.0	69.5			67.5		62.4/30.0m				30.0
	34.0	60.9			59.1		57.1		52.2/34.0m		34.0
	38.0	54.0			52.3		50.4		48.7		38.0
	42.0	47.8			46.6		44.9		43.3		42.0
	46.0	42.1	30.9/46.0m		41.0		39.8		38.8		46.0
	50.0	37.5	27.6		36.4	25.8/50.0m	35.2	24.0/50.0m	34.2		50.0
	54.0	33.6	24.4		32.4	23.1	31.3	21.7	30.3	19.6/54.0m	54.0
	58.0	30.3/58.0m	21.7		29.1	20.4	27.9	19.0	26.9	17.9	58.0
	62.0		19.3	11.8/62.0m	26.3	18.0	25.1	16.7	24.1	15.6	62.0
	66.0		17.3	10.2	23.9/66.0m	16.0	22.6	14.7	21.6	13.6	66.0
	70.0		15.6/70.0m	8.8		14.3	19.9/70.0m	13.0	18.5	11.9	70.0
	74.0			7.6/74.0m		12.8/74.0m		11.5	15.8	10.3	74.0
78.0							10.1	12.7/78.0m	9.0	78.0	
82.0							9.0/82.0m		7.8	82.0	
86.0									6.8/86.0m	86.0	
最大ジブ角度	71.7°	60.6°	52.9°	71.6°	59.4°	71.5°	62.5°	69.7°	61.4°	最大ジブ角度	
最小ジブ角度	24.4°	20.0°	34.1°	17.5°	24.2°	22.0°	18.0°	15.9°	22.1°	最小ジブ角度	
標準掛数		8			8		8		8	標準掛数	

※上表の場合、補助シーブ吊りはできません。

(単位:t)

ブーム長さ(m)		66.0															ブーム長さ(m)
ジブ長さ(m)		24.0			30.0			36.0			42.0			48.0			ジブ長さ(m)
ブーム角度		86°	76°	66°	86°	76°	66°	86°	76°	66°	86°	76°	66°	86°	76°	66°	ブーム角度
作業半径(m)	18.0	124.9/18.5m															18.0
	20.0	115.9			112.2/20.0m			107.8/20.0m									20.0
	22.0	105.7			102.4			100.4			95.1/22.0m						22.0
	24.0	98.1			95.1			92.4			89.6			84.5/24.0m			24.0
	26.0	90.8			87.9			85.4			82.8			80.4			26.0
	28.0	84.4			81.7			79.4			76.9			74.6			28.0
	30.0	77.3/30.0m			76.3			74.1			71.8			69.6			30.0
	34.0		53.1/34.0m		65.2			64.5			63.1			61.1			34.0
	38.0		46.8		56.4/38.0m	44.7/38.0m		55.8	42.8/38.0m		56.1			54.3			38.0
	42.0		40.9/42.0m			40.1		48.9/42.0m	39.1		49.2	36.0/42.0m		48.4			42.0
	46.0					35.4/46.0m			34.5		43.6/46.0m	34.6		42.8	30.2/46.0m		46.0
	50.0			25.0/50.0m			23.1/50.0m		30.7			30.8		38.3	29.7		50.0
	54.0			22.3/54.0m			21.2		27.5/54.0m	19.1/54.0m		27.6		34.5/54.0m	26.6		54.0
	58.0						18.9/58.0m			17.6	24.8/58.0m	15.3/58.0m		23.9			58.0
	62.0									15.6		15.3		21.6	12.0/62.0m		62.0
	66.0									13.9/66.0m			13.7		19.7/66.0m	12.0	66.0
70.0												12.1/70.0m			10.8/70.0m	70.0	
最大ジブ角度	67.9°	57.0°	40.6°	69.4°	55.3°	52.7°	73.0°	61.7°	52.0°	72.6°	59.9°	51.5°	72.4°	58.5°	51.1°	最大ジブ角度	
最小ジブ角度	30.3°	27.7°	21.4°	16.1°	32.8°	28.8°	24.5°	22.4°	17.3°	29.0°	27.5°	24.1°	21.1°	19.3°	37.2°	最小ジブ角度	
標準掛数	8			8			8			8			8			標準掛数	

※上表の場合、補助シーブ吊りはできません。

(単位:t)

ブーム長さ(m)		66.0								ブーム長さ(m)
ジブ長さ(m)		54.0		60.0		66.0		72.0		ジブ長さ(m)
ブーム角度		86°	76°	86°	76°	86°	76°	86°	76°	ブーム角度
作業半径(m)	26.0	75.2/26.0m								26.0
	28.0	72.3		66.6/28.0m						28.0
	30.0	67.3		65.3		57.6/30.0m				30.0
	34.0	59.0		57.2				48.2/34.0m		34.0
	38.0	52.3		50.6		48.8		46.4		38.0
	42.0	46.8		45.2		43.4		41.8		42.0
	46.0	42.2	28.3/46.0m	40.6		38.8		37.4		46.0
	50.0	37.5	28.0	35.3	23.5/50.0m	33.4		31.9		50.0
	54.0	33.4	25.2	31.0	23.5	29.0	19.5/54.0m	27.3	17.9/54.0m	54.0
	58.0	30.1/58.0m	22.8	27.5	21.4	25.3	19.5	23.5	17.9	58.0
	62.0		20.7	24.6	19.3	22.2	17.8	20.3	16.4	62.0
	66.0		18.9	22.4/66.0m	17.5	19.6	16.0	17.6/66.0m	14.7	66.0
70.0		17.2/70.0m		16.0	17.5/70.0m	14.4		13.1	70.0	
74.0				14.5		13.0		11.7	74.0	
78.0				13.0/78.0m		11.7		10.5	78.0	
82.0						10.4/82.0m		9.3/82.0m	82.0	
最大ジブ角度	72.2°	62.3°	72.0°	61.0°	71.9°	59.9°	70.1°	62.7°		最大ジブ角度
最小ジブ角度	25.4°	24.2°	18.8°	17.2°	22.9°	21.8°	38.1°	31.8°		最小ジブ角度
標準掛数	8		8		8		8			標準掛数

※上表の場合、補助シーブ吊りはできません。

STANDARD

▶ ラフティングジブ定格総荷重表 (シングルドラム仕様)

(単位 : t)

ブーム長さ(m)		30.0															ブーム長さ(m)
ジブ長さ(m)		24.0			30.0			36.0			42.0			48.0			ジブ長さ(m)
ブーム角度		86°	76°	66°	86°	76°	66°	86°	76°	66°	86°	76°	66°	86°	76°	66°	ブーム角度
作業半径(m)	14.0	174.0/14.0m															14.0
	15.0	174.0															15.0
	16.0	170.7			152.0/16.0m												16.0
	17.0	160.6			152.0												17.0
	18.0	151.7			151.7			140.0/18.0m									18.0
	20.0	134.3			134.3			133.2			112.0/20.0m						20.0
	22.0	119.1			119.1			118.4			112.0			98.0/22.0m			22.0
	24.0	106.3	99.6/24.0m		106.3			105.6			105.6			98.0			24.0
	26.0	95.8	89.8		95.8	89.5/26.0m		95.1			95.1			94.4			26.0
	28.0	85.8/28.0m	81.6		87.1	81.4		86.4			86.4			85.7			28.0
	30.0		74.7		79.7	74.4		79.1	73.6/30.0m		79.1			78.4			30.0
	34.0		63.6/34.0m	59.4/34.0m	66.6/34.0m	63.4		67.4	62.6		67.3	62.5/34.0m		66.6			34.0
	38.0			51.5/38.0m		55.0/38.0m	51.2/38.0m	58.5/38.0m	54.2		58.4	54.1		57.7	53.2/38.0m		38.0
	42.0						44.9/42.0m		47.7	44.1/42.0m	51.3	47.5		50.6	46.7		42.0
	46.0							42.4/46.0m	39.1	45.6/46.0m	42.1	38.8/46.0m		44.9	41.3		46.0
	50.0								35.1/50.0m		37.7/50.0m	34.7	40.3/50.0m	37.0	33.5/50.0m		50.0
	54.0												31.3/54.0m		33.3	30.0	54.0
58.0														30.2/58.0m	27.1	58.0	
62.0															24.5/62.0m	62.0	
最大ジブ角度	72.9°	60.6°	45.4°	72.4°	62.7°	46.0°	72.1°	60.4°	46.4°	71.9°	58.8°	46.6°	71.7°	57.5°	46.8°	最大ジブ角度	
最小ジブ角度	27.6°	23.7°	29.3°	24.6°	30.2°	33.9°	29.8°	19.1°	23.7°	20.6°	25.3°	28.4°	25.6°	16.5°	20.4°	最小ジブ角度	
標準掛数	13			11			10			8			7			標準掛数	

(単位 : t)

ブーム長さ(m)		30.0											ブーム長さ(m)	
ジブ長さ(m)		54.0			60.0			66.0			72.0		ジブ長さ(m)	
ブーム角度		86°	76°	66°	86°	76°	66°	86°	76°	66°	86°	76°	66°	ブーム角度
作業半径(m)	24.0	98.0/24.0m												24.0
	26.0	93.8			84.0/26.0m									26.0
	28.0	85.1			84.0			70.0/28.0m						28.0
	30.0	77.7			77.0			70.0			63.3/30.0m			30.0
	34.0	66.0			65.3			64.5			58.7			34.0
	38.0	57.1	52.5/38.0m		56.3			55.5			51.8			38.0
	42.0	50.0	46.0		49.3	45.1/42.0m		48.5			46.5			42.0
	46.0	44.3	40.6		43.6	39.8		42.8	38.6/46.0m		42.1	37.6/46.0m		46.0
	50.0	39.6	36.3	32.5/50.0m	38.9	35.4		38.1	34.2		37.4	33.1		50.0
	54.0	35.7	32.6	29.0	35.0	31.6	27.7/54.0m	34.2	30.4		33.5	29.3		54.0
	58.0	32.5/58.0m	29.5	26.0	31.7	28.4	24.8	30.9	27.2	23.5/58.0m	30.0	26.1		58.0
	62.0		26.9/62.0m	23.5	28.9/62.0m	25.6	22.2	28.0	24.4	20.9	27.0	23.4	19.8/62.0m	62.0
	66.0			21.3/66.0m		23.3/66.0m	20.0	25.5	22.0	18.7	24.4	21.0	17.6	66.0
	70.0						18.1	22.9/70.0m	20.0	16.8	21.1	18.9	15.7	70.0
	74.0						16.5/74.0m		18.2/74.0m	15.2	18.3/74.0m	17.1	14.1	74.0
	78.0									13.7/78.0m		15.5/78.0m	12.6	78.0
	82.0												11.3	82.0
86.0												10.2/86.0m	86.0	
最大ジブ角度	71.6°	61.5°	52.6°	71.5°	60.2°	52.2°	71.4°	59.2°	51.8°	71.3°	62.0°	51.5°	最大ジブ角度	
最小ジブ角度	18.1°	22.2°	24.9°	22.8°	25.9°	18.2°	16.3°	20.0°	22.5°	20.8°	23.6°	16.5°	最小ジブ角度	
標準掛数	7			6			5			5			標準掛数	

(単位：t)

ブーム長さ(m)		36.0															ブーム長さ(m)
ジブ長さ(m)		24.0			30.0			36.0			42.0			48.0			ジブ長さ(m)
ブーム角度		86°	76°	66°	86°	76°	66°	86°	76°	66°	86°	76°	66°	86°	76°	66°	ブーム角度
作業半径(m)	15.0	152.0/15.0m															15.0
	16.0	152.0															16.0
	17.0	152.0			140.0/17.0m												17.0
	18.0	151.2			140.0			126.0/18.0m									18.0
	20.0	133.1			133.2			126.0			112.0/20.0m						20.0
	22.0	118.5			118.5			117.5			112.0			98.0/22.0m			22.0
	24.0	105.7			105.8			105.1			104.2			98.0			24.0
	26.0	95.3	87.9/26.0m		95.3			94.7			94.7			94.0			26.0
	28.0	86.6	79.8		86.6	79.6/28.0m		86.0			86.0			85.3			28.0
	30.0	78.4/30.0m	73.0		79.3	72.8		78.7			78.7			78.0			30.0
	34.0		62.2/34.0m		67.6/34.0m	62.0		67.0	61.1/34.0m		67.0	61.0/34.0m		66.3			34.0
	38.0			49.3/38.0m		53.7	48.9/38.0m	58.1/38.0m	52.9		58.1	52.8		57.3	51.9/38.0m		38.0
	42.0			43.3/42.0m		47.2/42.0m	42.9		46.4	41.6/42.0m	51.0	46.3		50.3	45.5		42.0
	46.0						38.1/46.0m		41.2/46.0m	36.8	45.3/46.0m	41.1	36.5/46.0m	44.6	40.2		46.0
	50.0									32.9		36.8/50.0m	32.5	40.0/50.0m	35.9	31.2/50.0m	50.0
	54.0									29.6/54.0m			29.1		32.4	27.8	54.0
58.0												26.3/58.0m		29.3/58.0m	25.0	58.0	
62.0															22.6/62.0m	62.0	
最大ジブ角度	71.5°	59.1°	39.8°	71.3°	61.5°	52.3°	72.8°	55.6°	51.6°	72.5°	61.1°	51.1°	72.3°	59.5°	50.7°	最大ジブ角度	
最小ジブ角度	17.3°	31.4°	20.0°	26.5°	17.8°	27.9°	31.1°	25.4°	16.1°	22.2°	29.7°	23.4°	26.8°	21.9°	27.7°	最小ジブ角度	
標準掛数	11			10			9			8			7			標準掛数	

(単位：t)

ブーム長さ(m)		36.0											ブーム長さ(m)	
ジブ長さ(m)		54.0			60.0			66.0			72.0			ジブ長さ(m)
ブーム角度		86°	76°	66°	86°	76°	66°	86°	76°	66°	86°	76°	66°	ブーム角度
作業半径(m)	24.0	97.1/24.0m												24.0
	26.0	91.3			84.0/26.0m									26.0
	28.0	84.6			82.2			70.0/28.0m						28.0
	30.0	77.3			76.4			70.0			64.0/30.0m			30.0
	34.0	65.6			64.9			64.1			57.3			34.0
	38.0	56.7			56.0			55.2			51.7			38.0
	42.0	49.7	44.7/42.0m		48.9	43.5/42.0m		48.2			46.9			42.0
	46.0	44.0	39.5		43.3	38.2		42.5	37.0/46.0m		41.8			46.0
	50.0	39.4	35.1		38.6	33.9		37.8	32.6		37.1	31.5/50.0m		50.0
	54.0	35.5	31.4	26.7/54.0m	34.7	30.2		33.9	28.9		33.0	27.9		54.0
	58.0	32.2/58.0m	28.3	23.9	31.4	27.0	22.6/58.0m	30.5	25.8		29.5	24.7		58.0
	62.0		25.6/62.0m	21.5	28.6/62.0m	24.4	20.2	27.6	23.1	18.9/62.0m	26.5	22.1		62.0
	66.0			19.4		22.0	18.1	25.0	20.8	16.8	24.0	19.7	15.7/66.0m	66.0
	70.0			17.6/70.0m		20.1/70.0m	16.3	22.8/70.0m	18.8	15.0	21.0	17.7	13.8	70.0
	74.0					14.7/74.0m			17.0/74.0m	13.4	18.1/74.0m	15.9	12.3	74.0
	78.0									12.0		14.4	10.9	78.0
82.0									10.8/82.0m		12.0/82.0m	9.6	82.0	
86.0												8.6/86.0m	86.0	
最大ジブ角度	72.1°	58.4°	50.5°	71.9°	61.8°	50.2°	71.8°	60.7°	50.1°	71.7°	59.7°	49.9°	最大ジブ角度	
最小ジブ角度	19.5°	26.1°	20.6°	23.9°	19.5°	24.7°	17.6°	23.5°	18.6°	21.7°	17.8°	22.5°	最小ジブ角度	
標準掛数	7			6			5			5			標準掛数	

(単位 : t)

ブーム長さ(m)		42.0															ブーム長さ(m)	
ジブ長さ(m)		24.0			30.0			36.0			42.0			48.0			ジブ長さ(m)	
ブーム角度		86°	76°	66°	86°	76°	66°	86°	76°	66°	86°	76°	66°	86°	76°	66°	ブーム角度	
作業半径(m)	15.0	140.0/15.4m															15.0	
	16.0	140.0															16.0	
	17.0	140.0			126.0/17.0m												17.0	
	18.0	140.0			126.0												18.0	
	20.0	131.6			126.0			112.0/20.0m									20.0	
	22.0	117.3			117.2			112.0			98.0/22.0m			98.0/22.0m			22.0	
	24.0	105.2			105.2			104.1			98.0			98.0			24.0	
	26.0	94.7			94.8			94.1			94.0			91.3			26.0	
	28.0	86.1	77.5/28.0m		86.2			85.5			85.6			84.6			28.0	
	30.0	78.7/30.0m	71.2		78.9	70.9/30.0m		78.2			78.3			77.6			30.0	
	34.0		60.6		67.2/34.0m	60.4		66.5	59.4/34.0m		66.6			65.9			34.0	
	38.0		52.4/38.0m	46.0/38.0m		52.3		57.7	51.5		57.7	51.4/38.0m		57.0	50.1/38.0m		38.0	
	42.0			40.3/42.0m		45.9/42.0m	39.8/42.0m	50.7/42.0m	45.1		50.7	45.0		50.0	43.8		42.0	
	46.0						35.2		40.0/46.0m	33.9/46.0m	45.0/46.0m	39.9		44.3	38.7		46.0	
	50.0						31.4/50.0m			30.2		35.6	29.9/50.0m	39.7/50.0m	34.4		50.0	
	54.0										27.0/54.0m		32.0/54.0m	26.7		30.8	25.3/54.0m	54.0
	58.0													24.0		27.8/58.0m	22.7	58.0
	62.0													21.6/62.0m			20.3	62.0
66.0																18.4/66.0m	66.0	
最大ジブ角度	71.5°	57.5°	48.4°	72.1°	60.3°	48.3°	70.2°	58.4°	48.3°	70.2°	57.0°	48.3°	72.8°	61.5°	48.3°	最大ジブ角度		
最小ジブ角度	20.6°	15.4°	33.4°	28.3°	25.6°	20.4°	16.6°	30.5°	27.0°	23.7°	21.4°	17.1°	27.9°	26.2°	23.3°	最小ジブ角度		
標準掛数	10			9			8			7			7			標準掛数		

(単位 : t)

ブーム長さ(m)		42.0												ブーム長さ(m)
ジブ長さ(m)		54.0			60.0			66.0			72.0			ジブ長さ(m)
ブーム角度		86°	76°	66°	86°	76°	66°	86°	76°	66°	86°	76°	66°	ブーム角度
作業半径(m)	24.0	94.0/24.0m												24.0
	26.0	88.6			83.8/26.0m									26.0
	28.0	82.1			79.8			70.0/28.0m						28.0
	30.0	76.4			74.2			70.0			64.8/30.0m			30.0
	34.0	65.2			64.5			62.8			58.0			34.0
	38.0	56.3			55.6			54.8			52.3			38.0
	42.0	49.3	42.7/42.0m		48.6			47.8			47.0			42.0
	46.0	43.7	37.6		42.9	36.3/46.0m		42.1	35.0/46.0m		41.2			46.0
	50.0	39.0	33.4		38.3	32.1		37.4	30.8		36.4	29.7/50.0m		50.0
	54.0	35.2	29.8		34.4	28.5		33.4	27.3		32.4	26.2		54.0
	58.0	31.9/58.0m	26.7	21.5/58.0m	31.1	25.5		29.9	24.2		28.9	23.2		58.0
	62.0		24.1	19.2	28.2/62.0m	22.9	17.9/62.0m	27.0	21.6	16.6/62.0m	26.0	20.6		62.0
	66.0		21.9/66.0m	17.3		20.7	15.9	24.5	19.4	14.6	23.4	18.3	13.5/66.0m	66.0
	70.0			15.5		18.7/70.0m	14.2	22.3/70.0m	17.4	12.9	20.8	16.3	11.8	70.0
	74.0			14.1/74.0m			12.7		15.7	11.4	17.9/74.0m	14.6	10.3	74.0
	78.0						11.4/78.0m		14.3/78.0m	10.1		13.1	8.9	78.0
	82.0									8.9/82.0m		11.8/82.0m	7.8	82.0
	86.0												6.8	86.0
90.0												5.9/90.0m	90.0	
最大ジブ角度	72.5°	60.2°	48.3°	72.3°	59.0°	48.3°	72.2°	62.1°	52.8°	72.0°	61.0°	52.4°	最大ジブ角度	
最小ジブ角度	20.8°	18.8°	15.0°	24.9°	23.4°	20.7°	18.8°	17.0°	24.4°	22.6°	21.3°	18.9°	最小ジブ角度	
標準掛数	7			6			5			5			標準掛数	

(単位:t)

ブーム長さ(m)		48.0														ブーム長さ(m)	
ジブ長さ(m)		24.0			30.0			36.0			42.0			48.0			ジブ長さ(m)
ブーム角度		86°	76°	66°	86°	76°	66°	86°	76°	66°	86°	76°	66°	86°	76°	66°	ブーム角度
作業半径(m)	16.0	126.0/16.2m															16.0
	17.0	126.0			126.0/17.0m												17.0
	18.0	126.0			126.0												18.0
	20.0	126.0			124.7			112.0/20.0m									20.0
	22.0	115.8			113.4			110.1			98.0/22.0m						22.0
	24.0	104.2			103.9			101.8			98.0			93.8/24.0m			24.0
	26.0	94.2			94.3			93.6			91.2			88.6			26.0
	28.0	85.5	74.4/28.0m		85.7			85.0			84.5			82.1			28.0
	30.0	78.2/30.0m	68.3		78.4			77.7			77.8			76.5			30.0
	34.0		58.3		66.7/34.0m	58.1/34.0m		66.1	56.8/34.0m		66.2			65.5			34.0
	38.0		50.6/38.0m			50.4		57.2	49.1		57.3	49.1/38.0m		56.6			38.0
	42.0			37.0/42.0m		44.2/42.0m		50.3/42.0m	43.0		50.3	43.0		49.6	41.7/42.0m		42.0
	46.0			32.6/46.0m				32.2/46.0m	38.1		44.7/46.0m	38.0		44.0	36.7		46.0
	50.0							28.6/50.0m	34.0/50.0m	27.3/50.0m		33.8	27.1/50.0m	39.4	32.6		50.0
	54.0									24.3		30.3/54.0m	24.1	35.5/54.0m	29.1	22.7/54.0m	54.0
	58.0									21.9/58.0m				21.5	26.2	20.2	58.0
	62.0												19.3/62.0m		23.7/62.0m	18.0	62.0
66.0															16.1	66.0	
70.0															14.5/70.0m	70.0	
最大ジブ角度	70.5°	61.6°	43.1°	73.0°	54.4°	44.2°	70.9°	61.1°	44.9°	70.8°	59.3°	52.6°	70.8°	58.0°	52.1°	最大ジブ角度	
最小ジブ角度	23.4°	25.8°	25.6°	30.0°	31.5°	31.4°	18.9°	20.8°	20.7°	25.1°	26.4°	26.4°	16.2°	17.9°	17.8°	最小ジブ角度	
標準掛数	9			9			8			7			7			標準掛数	

(単位:t)

ブーム長さ(m)		48.0											ブーム長さ(m)	
ジブ長さ(m)		54.0			60.0			66.0			72.0			ジブ長さ(m)
ブーム角度		86°	76°	66°	86°	76°	66°	86°	76°	66°	86°	76°	66°	ブーム角度
作業半径(m)	24.0	84.0/24.0m												24.0
	26.0	84.0			81.1/26.0m									26.0
	28.0	79.6			77.4			70.0/28.0m						28.0
	30.0	74.1			72.0			69.8			65.0/30.0m			30.0
	34.0	64.8			63.0			60.9			58.6			34.0
	38.0	56.0			55.2			53.8			52.1			38.0
	42.0	49.0	40.6/42.0m		48.2			47.2			46.1			42.0
	46.0	43.4	35.6		42.6	34.3/46.0m		41.4			40.4			46.0
	50.0	38.7	31.5		37.8	30.2		36.7	28.9/50.0m		35.7	27.4/50.0m		50.0
	54.0	34.9	28.1		33.8	26.8		32.7	25.5		31.7	24.4		54.0
	58.0	31.6/58.0m	25.1	19.0/58.0m	30.5	23.9		29.3	22.6		28.3	21.5		58.0
	62.0		22.6	16.9	27.6/62.0m	21.4	15.5/62.0m	26.4	20.1		25.4	19.0		62.0
	66.0		20.5/66.0m	15.0		19.2	13.7	23.9	17.9	12.3/66.0m	22.8	16.8		66.0
	70.0			13.4		17.3	12.1	20.6/70.0m	16.0	10.7	20.2	14.9	9.5/70.0m	70.0
74.0			12.0/74.0m		15.7/74.0m	10.7		14.4	9.3	17.4/74.0m	13.3	8.1	74.0	
78.0						9.4		13.0/78.0m	8.1		11.8	6.9/78.0m	78.0	
82.0						8.4/82.0m			7.0/82.0m		10.5/82.0m		82.0	
最大ジブ角度	73.0°	61.9°	51.7°	72.7°	60.6°	51.3°	72.5°	59.6°	51.1°	72.4°	62.3°	50.8°	最大ジブ角度	
最小ジブ角度	22.1°	23.2°	23.1°	25.8°	16.0°	15.9°	19.9°	20.9°	29.2°	23.5°	24.3°	42.0°	最小ジブ角度	
標準掛数	6			6			5			5			標準掛数	

(単位：t)

ブーム長さ(m)	54.0															ブーム長さ(m)		
ジブ長さ(m)	24.0			30.0			36.0			42.0			48.0			ジブ長さ(m)		
ブーム角度	86°	76°	66°	86°	76°	66°	86°	76°	66°	86°	76°	66°	86°	76°	66°	ブーム角度		
作業半径(m)	17.0	126.0/17.0m														17.0		
	18.0	126.0			112.0/18.0m											18.0		
	20.0	124.3			112.0			98.0/20.0m								20.0		
	22.0	113.2			109.6			98.0				98.0/22.0m				22.0		
	24.0	102.8			101.5			98.0				95.6			84.0/24.0m	24.0		
	26.0	93.2			93.5			91.0				88.3			84.0	26.0		
	28.0	84.9			85.1			84.3				82.0			79.6	28.0		
	30.0	77.6/30.0m	65.3/30.0m		77.8			77.1				76.4			74.1	30.0		
	34.0		55.6		66.2/34.0m	55.5/34.0m		65.5				65.7			65.0	34.0		
	38.0		48.2/38.0m			48.0		56.7	46.7/38.0m			56.9	46.8/38.0m		56.2	38.0		
	42.0			33.6/42.0m		42.1		49.8/42.0m	40.8			49.9	40.8		49.2	39.5/42.0m	42.0	
	46.0			29.5/46.0m		37.2/46.0m	29.2/46.0m		36.0			44.3/46.0m	36.0		43.6	34.7	46.0	
	50.0						25.8		32.1/50.0m	24.4/50.0m			32.0		39.0	30.7	50.0	
	54.0						22.9/54.0m			21.6			28.6	21.4/54.0m	35.1/54.0m	27.4	54.0	
	58.0									19.3/58.0m			25.8/58.0m	19.0		24.5	17.6/58.0m	58.0
	62.0													17.0		22.1/62.0m	15.6	62.0
66.0													15.2/66.0m			13.8	66.0	
70.0															12.3/70.0m	7.0	70.0	
最大ジブ角度	69.6°	60.1°	51.2°	71.8°	57.8°	50.6°	71.6°	56.3°	50.2°	71.4°	61.6°	49.9°	71.3°	60.0°	49.7°	最大ジブ角度		
最小ジブ角度	25.9°	33.1°	37.2°	31.6°	20.0°	24.9°	20.9°	26.7°	30.0°	26.5°	16.7°	20.9°	18.0°	23.0°	25.9°	最小ジブ角度		
標準掛数	9			8			7			7			6			標準掛数		

(単位：t)

ブーム長さ(m)	54.0										ブーム長さ(m)	
ジブ長さ(m)	54.0			60.0			66.0		72.0		ジブ長さ(m)	
ブーム角度	86°	76°	66°	86°	76°	66°	86°	76°	86°	76°	ブーム角度	
作業半径(m)	26.0	80.8/26.0m									26.0	
	28.0	77.1			70.0/28.0m			69.9/28.0m			28.0	
	30.0	71.8			69.7			67.5		62.7/30.0m	30.0	
	34.0	62.9			61.0			59.0		57.2	34.0	
	38.0	55.5			54.0			52.1		50.4	38.0	
	42.0	48.6			47.5			46.3		44.8	42.0	
	46.0	43.0	33.6/46.0m		41.8	31.9/46.0m		40.7		39.7	46.0	
	50.0	38.3	29.7		37.1	28.3		36.0	26.5/50.0m	35.0	50.0	
	54.0	34.3	26.3		33.2	25.0		32.0	23.7	31.0	22.0/54.0m	54.0
	58.0	31.0/58.0m	23.5		29.8	22.2		28.6	20.9	27.6	19.8	58.0
	62.0		21.1	14.4/62.0m	27.0	19.8		25.8	18.5	24.7	17.4	62.0
	66.0		19.0/66.0m	12.7	23.2/66.0m	17.7	11.3/66.0m	23.3	16.4	22.2	15.3	66.0
	70.0			11.2		15.9	9.8	19.3/70.0m	14.6	19.4	13.5	70.0
	74.0			9.9		14.3/74.0m	8.5		13.0	16.7/74.0m	11.9	74.0
	78.0			8.8/78.0m			7.4/78.0m		11.6/78.0m		10.5	78.0
	82.0										9.2	82.0
86.0										8.2/86.0m	86.0	
最大ジブ角度	71.2°	58.8°	49.5°	71.2°	62.2°	49.4°	72.9°	61.0°	72.7°	60.0°	最大ジブ角度	
最小ジブ角度	23.2°	26.9°	18.4°	16.0°	20.5°	31.5°	21.0°	24.3°	24.3°	18.7°	最小ジブ角度	
標準掛数	6			5			5		5		標準掛数	

(単位:t)

ブーム長さ(m)		60.0														ブーム長さ(m)	
ジブ長さ(m)		24.0			30.0			36.0			42.0			48.0			ジブ長さ(m)
ブーム角度		86°	76°	66°	86°	76°	66°	86°	76°	66°	86°	76°	66°	86°	76°	66°	ブーム角度
作業半径(m)	17.0	112.0/17.8m															17.0
	18.0	112.0			98.0/18.0m												18.0
	20.0	112.0			98.0			98.0/20.0m									20.0
	22.0	109.3			98.0			98.0				84.0/22.0m					22.0
	24.0	101.3			98.0			95.4				84.0		84.0/24.0m			24.0
	26.0	93.2			90.7			88.1				84.0		83.0			26.0
	28.0	85.0			84.1			81.9				79.4		77.0			28.0
	30.0	77.8/30.0m			77.2			76.1				74.0		71.8			30.0
	34.0		53.9/34.0m		65.7/34.0m	52.6/34.0m		65.0				65.0		63.0			34.0
	38.0		46.7			45.4		56.2	44.0/38.0m			56.5		55.6			38.0
	42.0		40.8/42.0m			39.7		49.3/42.0m	38.4			49.5	38.5/42.0m	48.7	36.9/42.0m		42.0
	46.0			27.2/46.0m		35.0/46.0m			33.8			43.9/46.0m	33.8	43.1	32.5		46.0
	50.0			24.0/50.0m				22.6/50.0m	30.0/50.0m				30.0	38.5	28.7		50.0
	54.0							20.0				18.6/54.0m	26.7	34.6/54.0m	25.5		54.0
	58.0							17.8/58.0m				16.4	24.0/58.0m	16.2/58.0m	22.7		58.0
	62.0											14.6/62.0m		14.3	20.4/62.0m	12.9/62.0m	62.0
	66.0													12.7/66.0m		11.3	66.0
70.0															9.9	70.0	
74.0															8.7/74.0m	74.0	
最大ジブ角度		68.6°	52.7°	46.1°	72.6°	61.1°	46.6°	72.3°	59.0°	46.8°	72.0°	57.6°	47.0°	71.8°	62.0°	47.2°	最大ジブ角度
最小ジブ角度		28.1°	18.5°	30.3°	33.1°	27.1°	16.1°	22.7°	31.6°	24.5°	27.8°	22.8°	29.0°	19.6°	27.2°	21.1°	最小ジブ角度
標準掛数		8			7			7			6			6			標準掛数

(単位:t)

ブーム長さ(m)		60.0								ブーム長さ(m)	
ジブ長さ(m)		54.0		60.0		66.0		72.0		ジブ長さ(m)	
ブーム角度		86°	76°	66°	86°	76°	86°	76°	86°	76°	ブーム角度
作業半径(m)	26.0	77.9/26.0m									26.0
	28.0	74.6			69.8/28.0m						28.0
	30.0	69.5			67.5			62.4/30.0m			30.0
	34.0	60.9			59.1			57.1	52.2/34.0m		34.0
	38.0	54.0			52.3			50.4	48.7		38.0
	42.0	47.8			46.6			44.9	43.3		42.0
	46.0	42.1	30.9/46.0m		41.0			39.8	38.8		46.0
	50.0	37.5	27.6		36.4	25.8/50.0m	35.2	24.0/50.0m	34.2		50.0
	54.0	33.6	24.4		32.4	23.1	31.3	21.7	30.3	19.6/54.0m	54.0
	58.0	30.3/58.0m	21.7		29.1	20.4	27.9	19.0	26.9	17.9	58.0
	62.0		19.3	11.8/62.0m	26.3	18.0	25.1	16.7	24.1	15.6	62.0
	66.0		17.3	10.2	23.9/66.0m	16.0	22.6	14.7	21.6	13.6	66.0
	70.0		15.6/70.0m	8.8		14.3	19.9/70.0m	13.0	18.5	11.9	70.0
74.0			7.6/74.0m		12.8/74.0m		11.5	15.8	10.3	74.0	
78.0							10.1	12.7/78.0m	9.0	78.0	
82.0							9.0/82.0m		7.8	82.0	
86.0									6.8/86.0m	86.0	
最大ジブ角度		71.7°	60.6°	52.9°	71.6°	59.4°	71.5°	62.5°	69.7°	61.4°	最大ジブ角度
最小ジブ角度		24.4°	20.0°	34.1°	17.5°	24.2°	22.0°	18.0°	15.9°	22.1°	最小ジブ角度
標準掛数		6		5		5		4		標準掛数	

(単位：t)

ブーム長さ(m)	66.0															ブーム長さ(m)
ジブ長さ(m)	24.0			30.0			36.0			42.0			48.0			ジブ長さ(m)
ブーム角度	86°	76°	66°	86°	76°	66°	86°	76°	66°	86°	76°	66°	86°	76°	66°	ブーム角度
作業半径(m)	18.0	98.0/18.5m														18.0
	20.0	98.0			98.0/20.0m			84.0/20.0m								20.0
	22.0	98.0			98.0			84.0			84.0/22.0m					22.0
	24.0	98.0			95.1			84.0			84.0			70.0/24.0m		24.0
	26.0	90.8			87.9			84.0			82.8			70.0		26.0
	28.0	84.4			81.7			79.4			76.9			70.0		28.0
	30.0	77.3/30.0m			76.3			74.1			71.8			69.6		30.0
	34.0		53.1/34.0m		65.2			64.5			63.1			61.1		34.0
	38.0		46.8		56.4/38.0m	44.7/38.0m		55.8	42.8/38.0m		56.1			54.3		38.0
	42.0		40.9/42.0m			40.1		48.9/42.0m	39.1		49.2	36.0/42.0m		48.4		42.0
	46.0					35.4/46.0m			34.5		43.6/46.0m	34.6		42.8	30.2/46.0m	46.0
	50.0			25.0/50.0m			23.1/50.0m		30.7			30.8		38.3	29.7	50.0
	54.0			22.3/54.0m			21.2		27.5/54.0m	19.1/54.0m		27.6		34.5/54.0m	26.6	54.0
	58.0						18.9/58.0m			17.6		24.8/58.0m	15.3/58.0m		23.9	58.0
	62.0									15.6			15.3		21.6	12.0/62.0m
66.0									13.9/66.0m			13.7		19.7/66.0m	12.0	66.0
70.0												12.1/70.0m			10.8/70.0m	70.0
最大ジブ角度	67.9°	57.0°	40.6°	69.4°	55.3°	52.7°	73.0°	61.7°	52.0°	72.6°	59.9°	51.5°	72.4°	58.5°	51.1°	最大ジブ角度
最小ジブ角度	30.3°	27.7°	21.4°	16.1°	32.8°	28.8°	24.5°	22.4°	17.3°	29.0°	27.5°	24.1°	21.1°	19.3°	37.2°	最小ジブ角度
標準掛数	7			7			6			6			5			標準掛数

(単位：t)

ブーム長さ(m)	66.0								ブーム長さ(m)	
ジブ長さ(m)	54.0		60.0		66.0		72.0		ジブ長さ(m)	
ブーム角度	86°	76°	86°	76°	86°	76°	86°	76°	ブーム角度	
作業半径(m)	26.0	70.0/26.0m							26.0	
	28.0	70.0		56.0/28.0m					28.0	
	30.0	67.3		56.0		56.0/30.0m			30.0	
	34.0	59.0		56.0		55.2		42.0/34.0m	34.0	
	38.0	52.3		50.6		48.8		42.0	38.0	
	42.0	46.8		45.2		43.4		41.8	42.0	
	46.0	42.2	28.3/46.0m	40.6		38.8		37.4	46.0	
	50.0	37.5	28.0	35.3	23.5/50.0m	33.4		31.9	50.0	
	54.0	33.4	25.2	31.0	23.5	29.0	19.5/54.0m	27.3	17.9/54.0m	54.0
	58.0	30.1/58.0m	22.8	27.5	21.4	25.3	19.5	23.5	17.9	58.0
	62.0		20.7	24.6	19.3	22.2	17.8	20.3	16.4	62.0
	66.0		18.9	22.4/66.0m	17.5	19.6	16.0	17.6/66.0m	14.7	66.0
	70.0		17.2/70.0m		16.0	17.5/70.0m	14.4		13.1	70.0
74.0				14.5		13.0		11.7	74.0	
78.0				13.0/78.0m		11.7		10.5	78.0	
82.0						10.4/82.0m		9.3/82.0m	82.0	
最大ジブ角度	72.2°	62.3°	72.0°	61.0°	71.9°	59.9°	70.1°	62.7°	最大ジブ角度	
最小ジブ角度	25.4°	24.2°	18.8°	17.2°	22.9°	21.8°	38.1°	31.8°	最小ジブ角度	
標準掛数	5		4		4		3		標準掛数	

HEAVY LIFT

▶ 定格総荷重

- 定格総荷重とは、水平堅土上における転倒荷重の78%以内で、フックブロック、玉掛用ワイヤロープ等のつり具の質量を含んだ値です。
- 作業半径とはクレーン旋回中心よりつり上荷重の重心までの水平距離を意味します。
- 実際につり上げ得る荷重は定格総荷重から（フック＋玉掛用ワイヤロープ等のつり具）の質量を差し引いた値になります。
- 定格総荷重をつる場合にも風の影響、地盤の状態、作業速度その他安全作業に有害な状況がある時はオペレータは荷重の軽減、作業速度を遅くするなど状況に応じた判断をする責任があります。
- 表中の空欄の箇所では作業を行うことができません。
- すべてのブーム長さにおける中間ブームの構成は取扱説明書の指示を厳守してください。
- 主ブームに補助シーブを取り付けたままで主フックを使用する場合の定格総荷重は、主ブーム定格総荷重から、一律0.7t差し引いた値となります。ただし最小定格総荷重はメインブーム（ラフティング上部）は7.7t、ロングブームは6.2tとします。
- 補助シーブを装着できる主ブーム長さは下記のとおりです。
[HEAVY LIFT]
メインブーム（ラフティング上部）：36.0m～84.0m
ロングブーム：90.0m～108.0m
- ラフティングジブが装着された状態では、主ブームづりはできません。
- 巻上げロープ巻掛本数に対する最大巻上荷重とフックの質量

フック 呼称	最大巻上荷重 (t)																				フック 質量	
	1本掛	2本掛	3本掛	4本掛	5本掛	6本掛	7本掛	8本掛	9本掛	10本掛	11本掛	12本掛	13本掛	14本掛	15本掛	16本掛	20本掛	24本掛	28本掛	36本掛		44本掛
500t	-	-	-	-	-	-	-	112	-	-	-	164	-	-	-	220	280	336	370	450	500	11.7t
300t	-	-	-	-	-	-	-	112	-	-	-	164	-	-	-	220	280	300	-	-	-	7.8t
200t	-	28	42	56	70	84	98	112	126	140	152	164	174	184	192	200	-	-	-	-	-	7.1t
120t	-	28	42	56	70	84	98	112	120	-	-	-	-	-	-	-	-	-	-	-	-	4.5t
70t	-	28	42	56	70	-	-	-	-	-	-	-	-	-	-	-	-	-	-	-	-	3.1t
40t	-	28	40	-	-	-	-	-	-	-	-	-	-	-	-	-	-	-	-	-	-	2.0t
14t ボールフック	14	-	-	-	-	-	-	-	-	-	-	-	-	-	-	-	-	-	-	-	-	0.9t

500t、300tフックはダブルドラムの値です。

- ストラットガイラインをブーム上面に搭載した状態で作業する場合の定格総荷重は、定格総荷重表から下表の値を差し引いた値となります。

ヘビーブーム、ラフティング上部

ブーム長さ (m)	36	42	48	54	60	66	72	78	84
差し引き能力 (t)	0.7	0.9	1.0	1.2	1.4	1.5	1.7	1.9	2.1

ロングブーム

ブーム長さ (m)	90	96	102	108
差し引き能力 (t)	1.7	1.7	1.8	1.8

HEAVY LIFT

▶ ブームおよびガイラインの構成

■ ヘビーブーム

ブームの種類		
記号	ブーム長さ	仕様
	9.0m	下部ブーム
	3.0m	ブーム
	6.0m	ブーム
	9.0m	ブーム
	8.0m	テーパーブーム
	3.0m	ヘビー上部ブーム

記号	ガイライン		形式
	径 (mm)	長さ (m)	
A	—	3.00	リンクアッセン
B	—	6.00	リンクアッセン
C	—	9.00	リンクアッセン
E	—	8.00	リンクアッセン
a	—	2.30	リンク
b	—	0.23	リンクアッセン
c	—	4.77	リンク
d	—	1.23	リンクアッセン
e	—	0.33	リンク

※印は、これより短いブームの組立可能な構成を示します。

ブーム長さ	ブーム及びガイライン構成
36m	
42m	
48m	
54m	
60m	
66m	
72m	
78m	
84m	

HL マスト及びガイライン構成

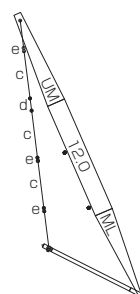

■ メインブーム (ラフティング上部)

ブームの種類		
記号	ブーム長さ	仕様
	9.0m	下部ブーム
	3.0m	ブーム
	6.0m	ブーム
	9.0m	ブーム
	8.0m	テーパーブーム
	3.0m	ラフティング上部ブーム

記号	ガイドライン		形式
	径 (mm)	長さ (m)	
A	—	3.00	リンクアッセン
B	—	6.00	リンクアッセン
C	—	9.00	リンクアッセン
E	—	8.00	リンクアッセン
a	—	2.30	リンク
b	—	0.23	リンクアッセン
c	—	4.77	リンク
d	—	1.23	リンクアッセン
e	—	0.33	リンク

※印は、これより短いブームの組立可能な構成を示します。

ブーム長さ	ブーム及びガイドライン構成
36m	
42m	
48m	
54m	
60m	
66m	
72m	
78m	
84m	
HLマスト及びガイドライン構成	

HEAVY LIFT

▣ ロングブーム

ブームの種類		
記号	ブーム長さ	仕様
	9.0m	下部ブーム
[6.0]	6.0m	ブーム
[9.0]	9.0m	ブーム
[8T]	8.0m	テーパブーム
[30]	3.0m	ジブ兼用
[6.0L]	6.0m	ジブ兼用
[9.0L]	9.0m	ジブ兼用
[5TL]	5.0m	ジブ兼用テーパブーム
UL	8.0m	上部ジブ兼用

記号	ガイドライン		形式
	径 (mm)	長さ (m)	
A	—	3.00	リンクアッセン
B	—	6.00	リンクアッセン
C	—	9.00	リンクアッセン
E	—	8.00	リンクアッセン
a	—	2.30	リンク
b	—	0.23	リンク
P	φ44	7.20	ケーブル
J	φ44	3.00	ケーブル
K	φ44	6.00	ケーブル
L	φ44	9.00	ケーブル
R	φ44	4.50	ケーブル
Mc	—	0.90	リンクアッセン
	—	4.60	ケーブル
	—	0.34	リンク
	—	1.10	
	—	0.78	
	—	0.78	リンク
	—	1.10	
q	—	0.50	リンクアッセン

※印は、これより短いブームの組立可能な構成を示します。

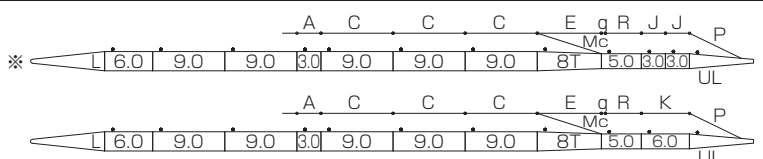
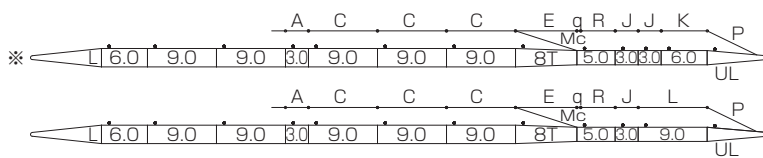
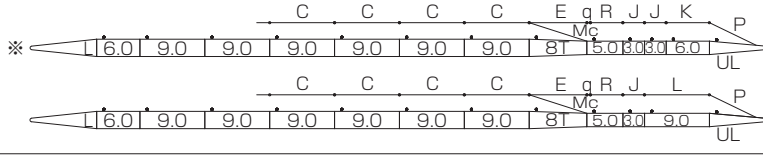
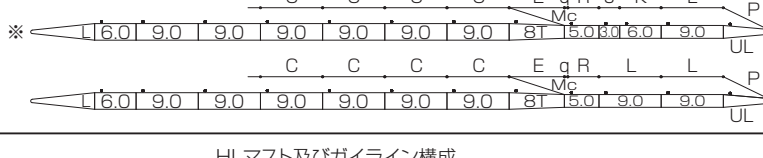
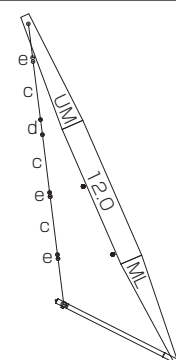
ブーム長さ	ブーム及びガイドライン構成
90m	
96m	
102m	
108m	
HLマスト及びガイドライン構成	
	

ラフティングジブ

ブームの種類		
記号	ブーム長さ	仕様
	9.0m	下部ブーム
	3.0m	ブーム
	6.0m	ブーム
	9.0m	ブーム
	8.0m	テーパーブーム
	3.0m	ラフティング上部ブーム

記号	ガイドライン		形式
	径 (mm)	長さ (m)	
A	—	3.00	リンクアッセン
B	—	6.00	リンクアッセン
C	—	9.00	リンクアッセン
E	—	8.00	リンクアッセン
a	—	2.30	リンク
b	—	0.23	リンクアッセン

記号	ガイドライン		形式
	径 (mm)	長さ (m)	
m	—	2.96	リンク
n	—	1.00	リンク
c	—	4.77	リンク
d	—	1.23	リンクアッセン
e	—	0.33	リンク

※印は、これより短いブームの組立可能な構成を示します。

ブーム長さ	ブーム及びガイドライン構成
36m	
42m	
48m	
54m	
60m	
66m	
HLマスト及びガイドライン構成	

HEAVY LIFT

ジブの種類		
記号	ジブ長さ	仕様
	10.0m	下部ジブ
	3.0m	ジブ
	6.0m	ジブ
	9.0m	ジブ
	8.0m	上部ジブ

記号	ガイドライン		形式
	径 (mm)	長さ (m)	
N	φ44	10.0	ケーブル
P	φ44	7.20	ケーブル
J	φ44	3.00	ケーブル
K	φ44	6.00	ケーブル
L	φ44	9.00	ケーブル
S	φ34	10.0	ケーブル
T	φ34	9.15	ケーブル
Md	—	0.68	リンクアッセン

※印は、これより短いブームの組立可能な構成を示します。

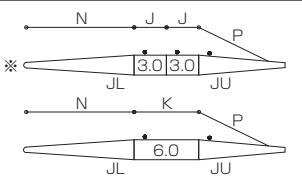
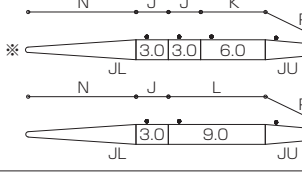
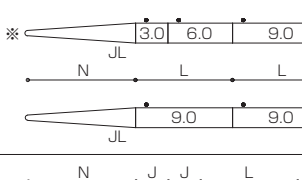
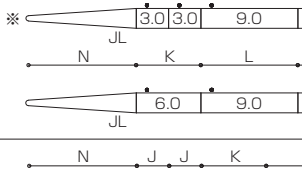
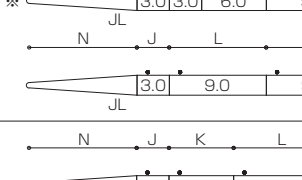
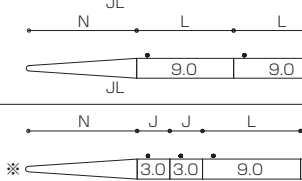
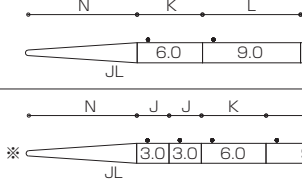
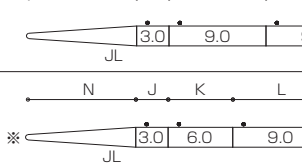
ジブ長さ	ジブ及びガイドライン構成
24m	
30m	
36m	
42m	
48m	
54m	
60m	
66m	
72m	

HEAVY LIFT

▶ クレーン作動範囲図

■ ヘビーブーム

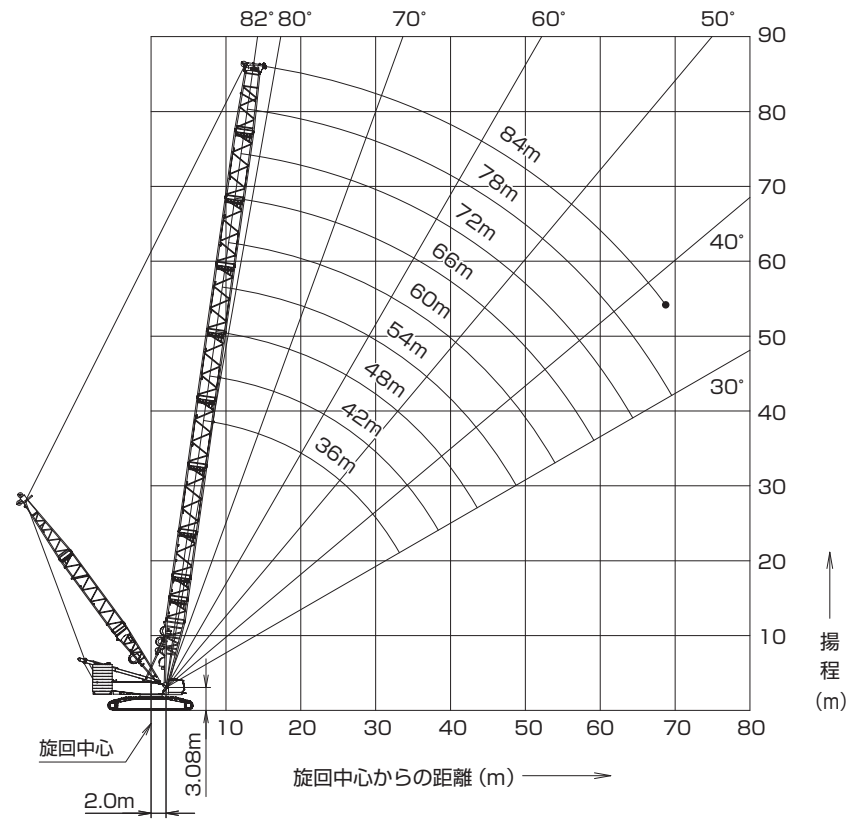

■ メインブーム (ラフティング上部)

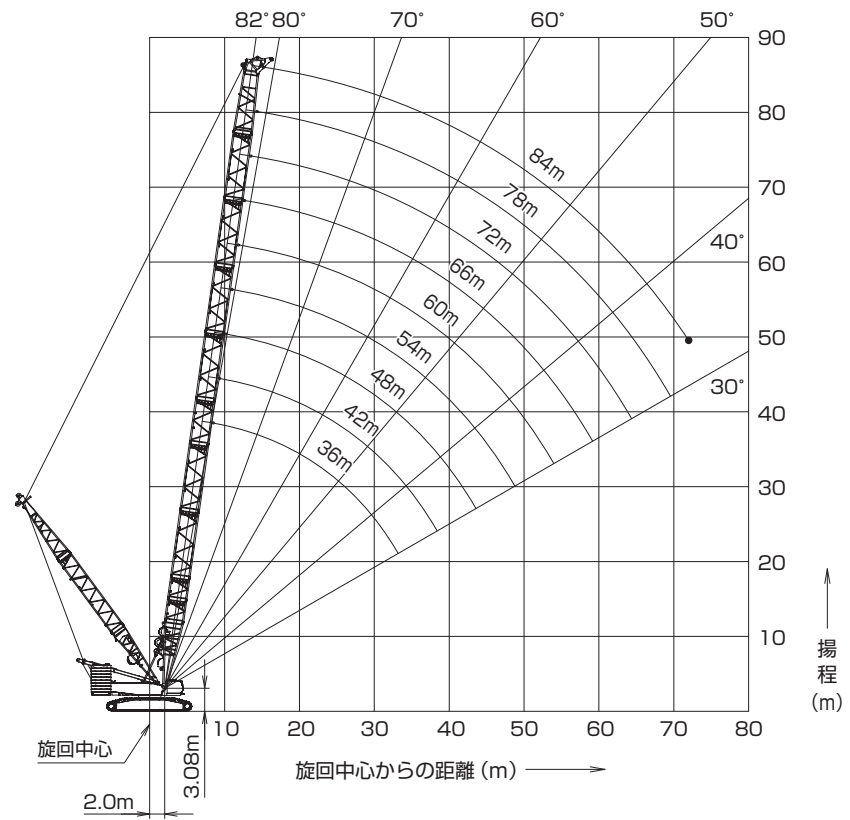

▣ ロングブーム

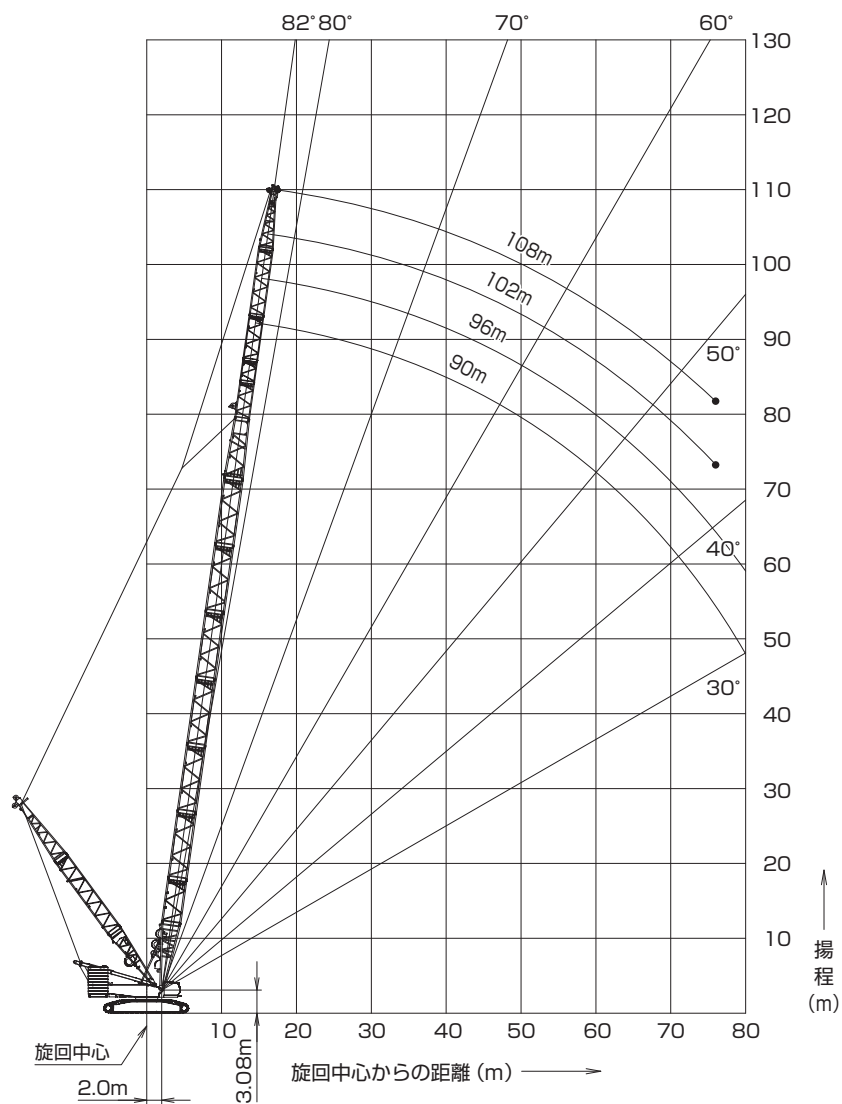

HEAVY LIFT

▶ ヘビーブーム定格総荷重表 (ダブルドラム仕様)

(単位: t)

ジブ長さ (m) 作業半径(m)	36.0	42.0	48.0	54.0	60.0	66.0	72.0	78.0	84.0	ジブ長さ (m) 作業半径(m)
8.0	370.0/8.3m									8.0
9.0	353.3	336.0/9.2m								9.0
10.0	308.5	309.1	309.5	276.1/10.9m	251.2/11.7m					10.0
12.0	243.3	243.6	243.7	243.5	243.0	220.0/12.5m	201.2/13.4m			12.0
14.0	199.8	199.9	199.8	199.5	198.9	198.1	192.1	182.3/14.2m	164.0/15.0m	14.0
16.0	168.8	168.7	168.5	168.1	167.4	166.5	165.7	160.8	155.2	16.0
18.0	145.5	145.3	145.0	144.5	143.7	142.9	142.0	141.0	136.8	18.0
20.0	127.4	127.1	126.8	126.2	125.4	124.5	123.6	122.6	121.5	20.0
22.0	112.9	112.6	112.2	111.6	110.7	109.8	108.9	107.8	106.7	22.0
24.0	101.1	100.7	100.2	99.6	98.7	97.7	96.8	95.8	94.6	24.0
26.0	91.2	90.7	90.3	89.6	88.7	87.7	86.8	85.7	84.6	26.0
28.0	82.8	82.3	81.9	81.2	80.2	79.2	78.3	77.2	76.0	28.0
30.0	75.6	75.1	74.6	73.9	73.0	72.0	71.0	69.9	68.7	30.0
32.0	69.4	68.9	68.4	67.7	66.7	65.7	64.7	63.6	62.4	32.0
34.0	64.4/33.8m	63.4	62.9	62.2	61.2	60.2	59.2	58.1	56.9	34.0
36.0		58.6	58.1	57.4	56.4	55.3	54.3	53.2	52.0	36.0
38.0		54.3	53.8	53.0	52.1	51.0	50.0	48.9	47.7	38.0
40.0		52.3/39.0m	49.9	49.2	48.2	47.1	46.1	45.0	43.8	40.0
44.0			43.3	42.6	41.6	40.5	39.5	38.4	37.2	44.0
48.0			43.0/44.2m	37.1	36.1	35.0	34.0	32.9	31.7	48.0
52.0				35.4/49.4m	31.5	30.4	29.4	28.3	27.1	52.0
56.0					28.9/54.6m	26.5	25.5	24.4	23.1	56.0
60.0						23.3/59.8m	22.1	21.0	19.8	60.0
64.0							19.2	18.0	16.8	64.0
68.0							18.5/65.0m	15.4	14.2/68.0m	68.0
72.0								14.1/70.2m		72.0
最大ジブ角度	82.0°	81.9°	82.0°	81.9°	82.0°	82.0°	81.9°	82.0°	82.0°	最大ジブ角度
最小ジブ角度	30.1°	30.1°	30.1°	30.1°	30.0°	30.0°	30.0°	30.0°	39.1°	最小ジブ角度
標準掛数	28	24	24	20	20	16	16	16	12	標準掛数

※上表は、ヘビーリフト用マストポイント位置が 11m, 13m, 16m それぞれの場合です。

HEAVY LIFT

▶ メインブーム (ラフティング上部) 定格総荷重表 (ダブルドラム仕様)

(単位:t)

ブーム長さ (m) 作業半径(m)	36.0	42.0	48.0	54.0	60.0	66.0	72.0	78.0	84.0	ブーム長さ (m) 作業半径(m)
8.0	300.0/8.5m									8.0
9.0	300.0	300.0/9.3m								9.0
10.0	286.5	287.1	280.5/10.2m	252.1/11.0m	225.4/11.8m					10.0
12.0	224.9	225.3	225.0	224.6	221.9	199.7/12.7m	178.2/13.5m			12.0
14.0	184.0	184.2	183.8	183.3	183.0	178.8	171.2	160.6/14.3m	145.2/15.2m	14.0
16.0	154.8	154.9	154.6	153.9	153.4	152.7	147.4	142.2	137.0	16.0
18.0	132.9	132.9	132.6	132.0	131.4	129.7	128.5	124.1	119.7	18.0
20.0	116.0	115.9	115.5	114.8	114.3	113.5	112.6	109.5	105.6	20.0
22.0	102.4	102.2	101.9	101.2	100.6	99.8	98.9	97.3	93.8	22.0
24.0	91.3	91.1	90.7	90.1	89.6	88.6	87.7	87.1	84.0	24.0
26.0	82.0	81.8	81.4	80.8	80.3	79.3	78.3	77.6	75.5	26.0
28.0	74.2	74.0	73.5	72.9	72.4	71.5	70.4	69.7	68.2	28.0
30.0	67.5	67.2	66.8	66.1	65.7	64.8	63.8	63.0	61.8	30.0
32.0	61.6	61.4	60.9	60.3	59.8	58.9	58.0	57.1	56.1	32.0
34.0	56.6/33.9m	56.3	55.8	55.1	54.7	53.8	52.8	52.0	51.1	34.0
36.0		51.7	51.3	50.6	50.2	49.3	48.3	47.4	46.4	36.0
38.0		47.7	47.3	46.6	46.1	45.3	44.3	43.6	42.6	38.0
40.0		45.6/39.1m	43.6	43.0	42.5	41.7	40.7	40.0	39.0	40.0
42.0			40.4	39.7	39.3	38.4	37.5	36.7	35.6	42.0
44.0			37.4	36.8	36.3	35.5	34.5	33.7	32.7	44.0
46.0			37.0/44.3m	34.1	33.7	32.8	31.8	31.0	30.0	46.0
48.0				31.6	31.2	30.4	29.3	28.5	27.3	48.0
50.0				29.9/49.5m	29.0	28.1	27.1	26.1	24.9	50.0
52.0					26.9	26.0	25.0	23.9	22.6	52.0
54.0					25.0	24.1	23.0	21.8	20.6	54.0
56.0					24.3/54.7m	22.4	21.2	20.0	18.7	56.0
58.0						20.7	19.5	18.3	16.9	58.0
60.0						19.2/59.9m	18.0	16.7	15.3	60.0
62.0							16.6	15.3	13.9	62.0
64.0							15.4	14.0	12.5	64.0
66.0							14.8/65.1m	12.8	11.2	66.0
68.0								11.7	10.0	68.0
70.0								10.6	8.8	70.0
72.0								10.5/70.3m	7.7/72.0m	72.0
最大ブーム角度	82.0°	82.0°	82.0°	82.0°	82.0°	82.0°	82.0°	82.0°	82.0°	最大ブーム角度
最小ブーム角度	30.1°	30.1°	30.1°	30.0°	30.0°	30.0°	30.0°	30.0°	34.6°	最小ブーム角度
標準掛数	24	24	24	20	20	16	16	12	12	標準掛数

※上表は、ヘビーリフト用マストポイント位置が11m, 13m, 16mそれぞれの場合です。

HEAVY LIFT

▶ メインブーム（ラフティング上部） 定格総荷重表（シングルドラム仕様）

（単位：t）

ブーム長さ 作業半径(m)	36.0	42.0	48.0	54.0	60.0	66.0	72.0	78.0	84.0	ブーム長さ 作業半径(m)
8.0	200.0/8.5m									8.0
9.0	200.0	200.0/9.3m								9.0
10.0	200.0	200.0	192.0/10.2m	174.0/11.0m	164.0/11.8m					10.0
12.0	200.0	200.0	192.0	174.0	164.0	152.0/12.7m	140.0/13.5m			12.0
14.0	184.0	184.2	183.8	174.0	164.0	152.0	140.0	126.0/14.3m	112.0/15.2m	14.0
16.0	154.8	154.9	154.6	153.9	153.4	152.0	140.0	126.0	112.0	16.0
18.0	132.9	132.9	132.6	132.0	131.4	129.7	128.5	124.1	112.0	18.0
20.0	116.0	115.9	115.5	114.8	114.3	113.5	112.6	109.5	105.6	20.0
22.0	102.4	102.2	101.9	101.2	100.6	99.8	98.9	97.3	93.8	22.0
24.0	91.3	91.1	90.7	90.1	89.6	88.6	87.7	87.1	84.0	24.0
26.0	82.0	81.8	81.4	80.8	80.3	79.3	78.3	77.6	75.5	26.0
28.0	74.2	74.0	73.5	72.9	72.4	71.5	70.4	69.7	68.2	28.0
30.0	67.5	67.2	66.8	66.1	65.7	64.8	63.8	63.0	61.8	30.0
32.0	61.6	61.4	60.9	60.3	59.8	58.9	58.0	57.1	56.1	32.0
34.0	56.6/33.9m	56.3	55.8	55.1	54.7	53.8	52.8	52.0	51.1	34.0
36.0		51.7	51.3	50.6	50.2	49.3	48.3	47.4	46.4	36.0
38.0		47.7	47.3	46.6	46.1	45.3	44.3	43.6	42.6	38.0
40.0		45.6/39.1m	43.6	43.0	42.5	41.7	40.7	40.0	39.0	40.0
42.0			40.4	39.7	39.3	38.4	37.5	36.7	35.6	42.0
44.0			37.4	36.8	36.3	35.5	34.5	33.7	32.7	44.0
46.0			37.0/44.3m	34.1	33.7	32.8	31.8	31.0	30.0	46.0
48.0				31.6	31.2	30.4	29.3	28.5	27.3	48.0
50.0				29.9/49.5m	29.0	28.1	27.1	26.1	24.9	50.0
52.0					26.9	26.0	25.0	23.9	22.6	52.0
54.0					25.0	24.1	23.0	21.8	20.6	54.0
56.0					24.3/54.7m	22.4	21.2	20.0	18.7	56.0
58.0						20.7	19.5	18.3	16.9	58.0
60.0						19.2/59.9m	18.0	16.7	15.3	60.0
62.0							16.6	15.3	13.9	62.0
64.0							15.4	14.0	12.5	64.0
66.0							14.8/65.1m	12.8	11.2	66.0
68.0								11.7	10.0	68.0
70.0								10.6	8.8	70.0
72.0								10.5/70.3m	7.7/72.0m	72.0
最大ブーム角度	82.0°	82.0°	82.0°	82.0°	82.0°	82.0°	82.0°	82.0°	82.0°	最大ブーム角度
最小ブーム角度	30.1°	30.1°	30.1°	30.0°	30.0°	30.0°	30.0°	30.0°	34.6°	最小ブーム角度
標準掛数	16	16	15	13	12	11	10	9	8	標準掛数

※上表は、ヘビーリフト用マストポイント位置が 11m, 13m, 16m それぞれの場合です。

HEAVY LIFT

▶ メインブーム (ラフティング上部) 補助シーブ定格総荷重表 (主ブームにフックなし / 2 本掛け)

(単位:t)

ブーム長さ 作業半径(m)	48.0	54.0	60.0	66.0	72.0	78.0	84.0	ブーム長さ 作業半径(m)
10.0	28.0/11.3m							10.0
12.0	28.0	28.0/12.1m	28.0/12.9m	28.0/13.8m				12.0
14.0	28.0	28.0	28.0	28.0	28.0/14.6m	28.0/15.4m		14.0
16.0	28.0	28.0	28.0	28.0	28.0	28.0	28.0/16.3m	16.0
18.0	28.0	28.0	28.0	28.0	28.0	28.0	28.0	18.0
20.0	28.0	28.0	28.0	28.0	28.0	28.0	28.0	20.0
22.0	28.0	28.0	28.0	28.0	28.0	28.0	28.0	22.0
24.0	28.0	28.0	28.0	28.0	28.0	28.0	28.0	24.0
26.0	28.0	28.0	28.0	28.0	28.0	28.0	28.0	26.0
28.0	28.0	28.0	28.0	28.0	28.0	28.0	28.0	28.0
30.0	28.0	28.0	28.0	28.0	28.0	28.0	28.0	30.0
32.0	28.0	28.0	28.0	28.0	28.0	28.0	28.0	32.0
34.0	28.0	28.0	28.0	28.0	28.0	28.0	28.0	34.0
36.0	28.0	28.0	28.0	28.0	28.0	28.0	28.0	36.0
38.0	28.0	28.0	28.0	28.0	28.0	28.0	28.0	38.0
40.0	28.0	28.0	28.0	28.0	28.0	28.0	28.0	40.0
42.0	28.0	28.0	28.0	28.0	28.0	28.0	28.0	42.0
44.0	28.0	28.0	28.0	28.0	28.0	28.0	28.0	44.0
46.0	28.0/44.3m	28.0	28.0	28.0	28.0	28.0	28.0	46.0
48.0		28.0	28.0	28.0	28.0	27.8	26.6	48.0
50.0		28.0/49.5m	28.0	27.4	26.4	25.4	24.2	50.0
52.0			26.2	25.3	24.3	23.2	21.9	52.0
54.0			24.3	23.4	22.3	21.1	19.9	54.0
56.0			23.6/54.7m	21.7	20.5	19.3	18.0	56.0
58.0				20.0	18.8	17.6	16.2	58.0
60.0				18.5/59.9m	17.3	16.0	14.6	60.0
62.0					15.9	14.6	13.2	62.0
64.0					14.7	13.3	11.8	64.0
66.0					14.1/65.1m	12.1	10.5	66.0
68.0						11.0	9.3	68.0
70.0						9.9	8.1/70.0m	70.0
72.0						9.8/70.3m		72.0
最大ブーム角度	82.0°	82.0°	82.0°	82.0°	82.0°	82.0°	82.0°	最大ブーム角度
最小ブーム角度	36.0°	35.3°	34.8°	34.4°	34.1°	33.7°	33.8°	最小ブーム角度
標準掛数	2	2	2	2	2	2	2	標準掛数

※上表は、ヘビーリフト用マストポイント位置が 11m, 13m, 16m
それぞれの場合です。

HEAVY LIFT

▶ メインブーム (ラフティング上部) 補助シーブ定格総荷重表 (主ブームにフックなし / 1 本掛け)

(単位: t)

ブーム長さ 作業半径(m)	48.0	54.0	60.0	66.0	72.0	78.0	84.0	ブーム長さ 作業半径(m)
10.0	14.0/11.6m							10.0
12.0	14.0	14.0/12.4m	14.0/13.2m	14.0/14.1m				12.0
14.0	14.0	14.0	14.0	14.0	14.0/14.9m	14.0/15.7m		14.0
16.0	14.0	14.0	14.0	14.0	14.0	14.0	14.0/16.6m	16.0
18.0	14.0	14.0	14.0	14.0	14.0	14.0	14.0	18.0
20.0	14.0	14.0	14.0	14.0	14.0	14.0	14.0	20.0
22.0	14.0	14.0	14.0	14.0	14.0	14.0	14.0	22.0
24.0	14.0	14.0	14.0	14.0	14.0	14.0	14.0	24.0
26.0	14.0	14.0	14.0	14.0	14.0	14.0	14.0	26.0
28.0	14.0	14.0	14.0	14.0	14.0	14.0	14.0	28.0
30.0	14.0	14.0	14.0	14.0	14.0	14.0	14.0	30.0
32.0	14.0	14.0	14.0	14.0	14.0	14.0	14.0	32.0
34.0	14.0	14.0	14.0	14.0	14.0	14.0	14.0	34.0
36.0	14.0	14.0	14.0	14.0	14.0	14.0	14.0	36.0
38.0	14.0	14.0	14.0	14.0	14.0	14.0	14.0	38.0
40.0	14.0	14.0	14.0	14.0	14.0	14.0	14.0	40.0
42.0	14.0	14.0	14.0	14.0	14.0	14.0	14.0	42.0
44.0	14.0	14.0	14.0	14.0	14.0	14.0	14.0	44.0
46.0	14.0/44.3m	14.0	14.0	14.0	14.0	14.0	14.0	46.0
48.0		14.0	14.0	14.0	14.0	14.0	14.0	48.0
50.0		14.0/49.5m	14.0	14.0	14.0	14.0	14.0	50.0
52.0			14.0	14.0	14.0	14.0	14.0	52.0
54.0			14.0	14.0	14.0	14.0	14.0	54.0
56.0			14.0/54.7m	14.0	14.0	14.0	14.0	56.0
58.0				14.0	14.0	14.0	14.0	58.0
60.0				14.0/59.9m	14.0	14.0	14.0	60.0
62.0					14.0	14.0	13.2	62.0
64.0					14.0	13.3	11.8	64.0
66.0					14.0/65.1m	12.1	10.5	66.0
68.0						11.0	9.3	68.0
70.0						9.9	8.1/70.0m	70.0
72.0						9.8/70.3m		72.0
最大ブーム角度	82.0°	82.0°	82.0°	82.0°	82.0°	82.0°	82.0°	最大ブーム角度
最小ブーム角度	36.6°	35.9°	35.3°	34.9°	34.5°	34.1°	40.1°	最小ブーム角度
標準掛数	1	1	1	1	1	1	1	標準掛数

※上表は、ヘビーリフト用マストポイント位置が 11m, 13m, 16m
それぞれの場合です。

HEAVY LIFT

▶ ロングブーム定格総荷重表

(単位:t)

ブーム長さ 作業半径(m)	90.0	96.0	102.0	108.0	ブーム長さ 作業半径(m)
14.0	98.0/15.0m	98.0/15.9m			14.0
16.0	98.0	98.0	84.0/16.6m	84.0/17.5m	16.0
18.0	98.0	98.0	84.0	84.0	18.0
20.0	98.0	98.0	84.0	84.0	20.0
22.0	95.7	95.7	84.0	84.0	22.0
24.0	87.7	87.7	84.0	84.0	24.0
26.0	81.0	81.0	81.0	81.0	26.0
28.0	75.2	75.2	75.2	75.0	28.0
30.0	70.2	70.2	70.2	68.9	30.0
32.0	65.4	65.3	64.1	63.4	32.0
34.0	59.9	59.7	58.5	58.3	34.0
36.0	55.0	54.8	53.6	53.4	36.0
38.0	50.7	50.5	49.3	49.1	38.0
40.0	46.8	46.6	45.4	45.2	40.0
44.0	40.2	40.0	38.7	38.5	44.0
48.0	34.7	34.5	33.2	33.0	48.0
52.0	30.1	29.8	28.6	28.4	52.0
56.0	26.1	25.9	24.7	24.4	56.0
60.0	22.7	22.5	21.3	21.1	60.0
64.0	19.8	19.5	18.2	18.0	64.0
68.0	17.1	16.7	15.4	15.2	68.0
72.0	14.6	14.2	12.9	12.7	72.0
76.0	12.4	12.0	10.7/76.0m	10.5/76.0m	76.0
80.0	10.5	10.1/80.0m			80.0
84.0	10.5/80.1m				84.0
最大ブーム角度	82.0°	82.0°	82.0°	81.9°	最大ブーム角度
最小ブーム角度	30.1°	35.9°	43.7°	47.0°	最小ブーム角度
標準掛数	7	7	6	6	標準掛数

※上表は、ヘビーリフト用マストポイント位置が11m、13m、16mそれぞれの場合です。

HEAVY LIFT

▶ ロング補助シーブ定格総荷重表（主ブームにフックなし /2 本掛け）

（単位：t）

ブーム長さ 作業半径(m)	90.0	96.0	102.0	108.0	ブーム長さ 作業半径(m)
14.0	28.0/15.9m				14.0
16.0	28.0	28.0/16.7m	28.0/17.5m		16.0
18.0	28.0	28.0	28.0	28.0/18.5m	18.0
20.0	28.0	28.0	28.0	28.0	20.0
22.0	28.0	28.0	28.0	28.0	22.0
24.0	28.0	28.0	28.0	28.0	24.0
26.0	28.0	28.0	28.0	28.0	26.0
28.0	28.0	28.0	28.0	28.0	28.0
30.0	28.0	28.0	28.0	28.0	30.0
32.0	28.0	28.0	28.0	28.0	32.0
34.0	28.0	28.0	28.0	28.0	34.0
36.0	28.0	28.0	28.0	28.0	36.0
38.0	28.0	28.0	28.0	28.0	38.0
40.0	28.0	28.0	28.0	28.0	40.0
44.0	28.0	28.0	28.0	28.0	44.0
48.0	28.0	28.0	28.0	28.0	48.0
52.0	28.0	28.0	27.9	27.7	52.0
56.0	25.4	25.2	24.0	23.7	56.0
60.0	22.0	21.8	20.6	20.4	60.0
64.0	19.1	18.8	17.5	17.3	64.0
68.0	16.4	16.0	14.7	14.5	68.0
72.0	13.9	13.5	12.2	12.0	72.0
76.0	11.7	11.3	10.0/76.0m	9.8/76.0m	76.0
80.0	9.8	9.4/80.0m			80.0
84.0	9.8/80.1m				84.0
最大ブーム角度	82.0°	82.0°	82.0°	81.9°	最大ブーム角度
最小ブーム角度	30.1°	35.9°	43.7°	47.0°	最小ブーム角度
標準掛数	2	2	2	2	標準掛数

※上表は、ヘビーリフト用マストポイント位置が11m, 13m, 16mそれぞれの場合です。

▶ ロング補助シーブ定格総荷重表（主ブームにフックなし /1 本掛け）

（単位：t）

ブーム長さ 作業半径(m)	90.0	96.0	102.0	108.0	ブーム長さ 作業半径(m)
16.0	14.0/16.2m	14.0/17.0m	14.0/17.8m		16.0
18.0	14.0	14.0	14.0	14.0/18.8m	18.0
20.0	14.0	14.0	14.0	14.0	20.0
22.0	14.0	14.0	14.0	14.0	22.0
24.0	14.0	14.0	14.0	14.0	24.0
26.0	14.0	14.0	14.0	14.0	26.0
28.0	14.0	14.0	14.0	14.0	28.0
30.0	14.0	14.0	14.0	14.0	30.0
32.0	14.0	14.0	14.0	14.0	32.0
34.0	14.0	14.0	14.0	14.0	34.0
36.0	14.0	14.0	14.0	14.0	36.0
38.0	14.0	14.0	14.0	14.0	38.0
40.0	14.0	14.0	14.0	14.0	40.0
44.0	14.0	14.0	14.0	14.0	44.0
48.0	14.0	14.0	14.0	14.0	48.0
52.0	14.0	14.0	14.0	14.0	52.0
56.0	14.0	14.0	14.0	14.0	56.0
60.0	14.0	14.0	14.0	14.0	60.0
64.0	14.0	14.0	14.0	14.0	64.0
68.0	14.0	14.0	14.0	14.0	68.0
72.0	13.9	13.5	12.2	12.0	72.0
76.0	11.7	11.3	10.0/76.0m	9.8/76.0m	76.0
80.0	9.8	9.4/80.0m			80.0
84.0	9.8/80.1m				84.0
最大ブーム角度	82.0°	82.0°	82.0°	82.0°	最大ブーム角度
最小ブーム角度	32.7°	38.0°	45.3°	48.4°	最小ブーム角度
標準掛数	1	1	1	1	標準掛数

※上表は、ヘビーリフト用マストポイント位置が11m, 13m, 16mそれぞれの場合です。

HEAVY LIFT

▶ ラフティングジブ作動範囲図

■ ラフティングジブ (ブーム角度 86°)

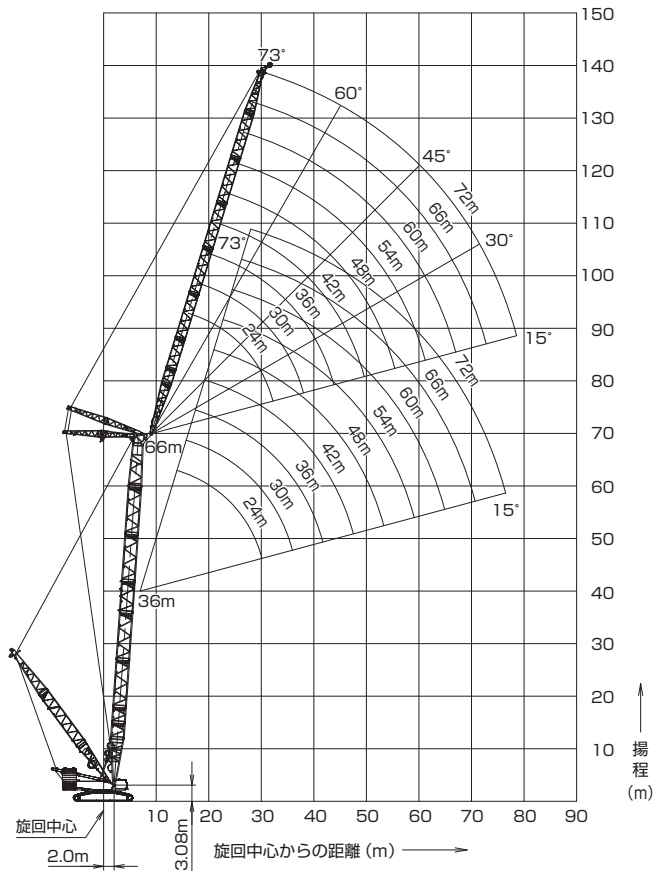

■ ラフティングジブ (ブーム角度 76°)

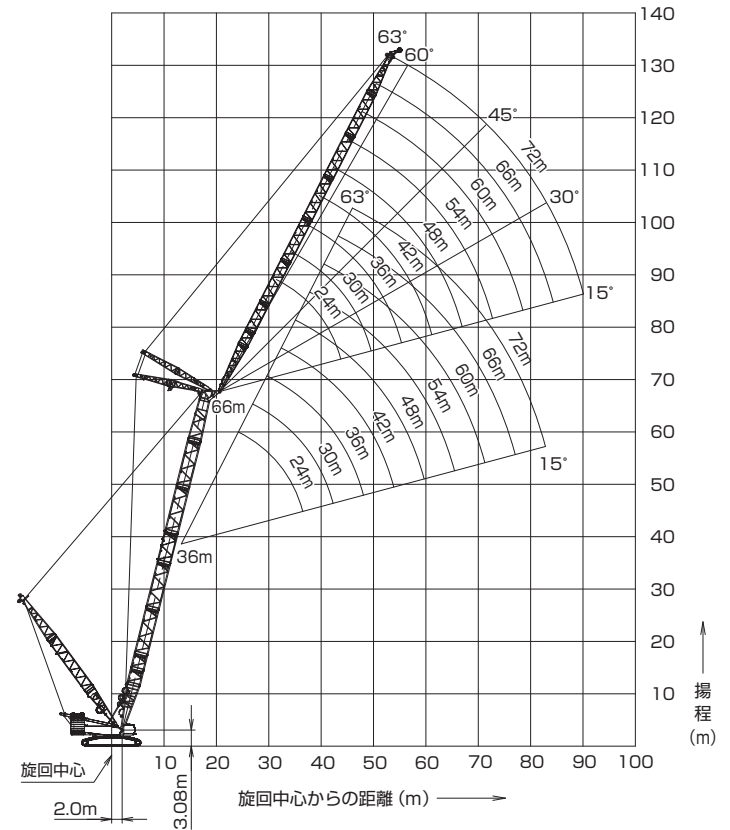

■ ラフティングジブ (ブーム角度 66°)

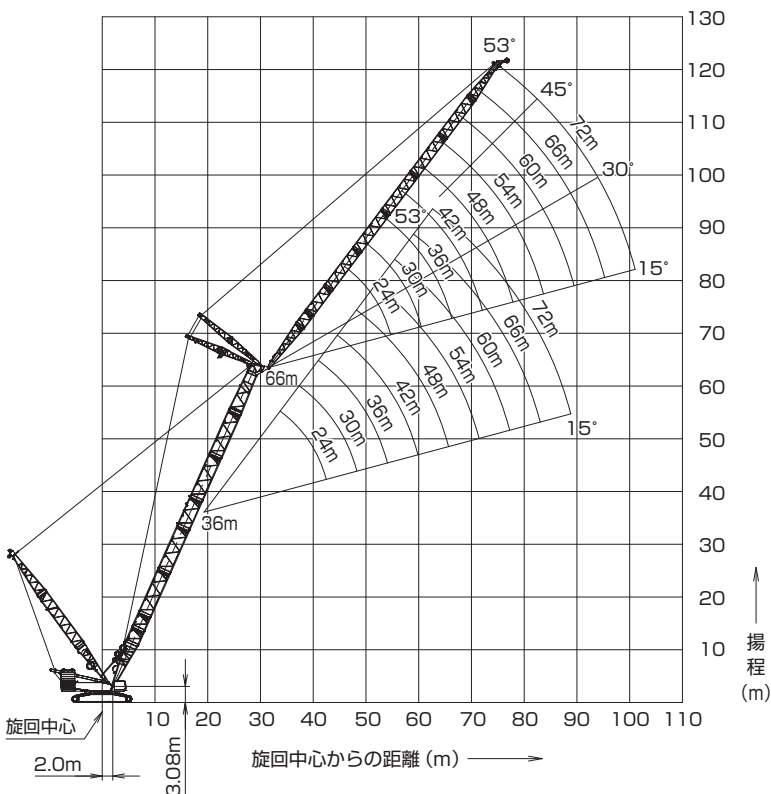

▶ ラフティングジブ定格総荷重表 (HL マストポイント半径 16m/ ダブルドラム仕様)

(単位 : t)

ブーム長さ(m)	36.0															ブーム長さ(m)	
ジブ長さ(m)	24.0			30.0			36.0			42.0			48.0			ジブ長さ(m)	
ブーム角度	86°	76°	66°	86°	76°	66°	86°	76°	66°	86°	76°	66°	86°	76°	66°	ブーム角度	
作業半径 (m)	14.0	200.0/14.4m														14.0	
	15.0	193.2														15.0	
	16.0	182.2														16.0	
	17.0	173.8			171.2/17.0m											17.0	
	18.0	162.5			161.9			161.1/18.0m								18.0	
	20.0	143.7			143.1			142.4				141.6/20.0m				20.0	
	22.0	128.5			128.0			127.3				126.6			125.7/22.0m	22.0	
	24.0	116.1			115.7			115.1				114.3			113.5	24.0	
	26.0	105.7	98.0/26.0m		105.4			104.8				104.1			103.3	26.0	
	28.0	96.9	89.9		96.6	89.1/28.0m		96.1				95.4			94.6	28.0	
	30.0	86.4/30.0m	82.9		89.1	82.2		88.6				87.9			87.2	30.0	
	34.0		71.4/34.0m		76.2/34.0m	70.7		76.1	70.2/34.0m			75.4	69.3/34.0m		74.6	34.0	
	38.0			57.6/38.0m		61.4	56.8/38.0m	66.1/38.0m	61.2			65.4	60.3		64.6	59.3/38.0m	38.0
	42.0			50.8/42.0m		54.1/42.0m	50.0		53.8	49.5/42.0m		57.6	52.9		56.7	52.0	42.0
	46.0						44.5/46.0m		47.9/46.0m	44.1	51.3/46.0m	47.0	43.1/46.0m		50.4	46.1	46.0
	50.0									39.6		42.2/50.0m	38.6	45.3/50.0m	41.3	37.6/50.0m	50.0
54.0									35.7/54.0m			34.8		37.3	33.8	54.0	
58.0												31.7/58.0m		33.9/58.0m	30.7	58.0	
62.0															28.0/62.0m	62.0	
最大ジブ角度	73.0°	59.1°	39.8°	71.3°	61.5°	52.3°	72.8°	55.6°	51.6°	72.5°	61.1°	51.1°	72.3°	59.5°	50.7°	最大ジブ角度	
最小ジブ角度	17.3°	31.4°	20.0°	26.5°	17.8°	27.9°	31.1°	25.4°	16.1°	22.8°	29.7°	23.4°	26.8°	21.9°	27.7°	最小ジブ角度	
標準掛数	16			16			12			12			12			標準掛数	

※上表は、ヘビーリフト用マストポイント位置が 16m の場合です。
 ジブが装着された状態では、ブーム吊りはできません。
 上表の場合、補助シーブ吊りはできません。

(単位 : t)

ブーム長さ(m)	36.0												ブーム長さ(m)	
ジブ長さ(m)	54.0			60.0			66.0			72.0			ジブ長さ(m)	
ブーム角度	86°	76°	66°	86°	76°	66°	86°	76°	66°	86°	76°	66°	ブーム角度	
作業半径 (m)	24.0	112.0/24.0m											24.0	
	26.0	102.6			100.9/26.0m								26.0	
	28.0	94.0			93.1				82.1/28.0m				28.0	
	30.0	86.5			85.7				77.6			64.3/30.0m	30.0	
	34.0	74.5			73.7				69.8			59.8	34.0	
	38.0	64.8			64.0				63.2			54.0	38.0	
	42.0	56.9	52.0/42.0m		56.1	51.1/42.0m			55.4			47.0	42.0	
	46.0	50.5	46.2		49.8	45.3			49.0	44.4/46.0m		42.8	46.0	
	50.0	45.3	41.3		44.5	40.5			43.8	39.6		39.2	38.8/50.0m	50.0
	54.0	40.9	37.2	33.6/54.0m	40.2	36.4			39.0	35.5		36.0	34.8	54.0
	58.0	37.2/58.0m	33.8	30.4	35.7	32.9	29.5/58.0m		34.0	32.1		32.6	31.3	58.0
	62.0		30.8/62.0m	27.6	31.5/62.0m	30.0	26.8	29.8	29.1	25.8/62.0m		28.3	28.4	62.0
	66.0			25.2		27.4	24.4	26.1	26.6	23.5	24.4	25.8	22.7/66.0m	66.0
	70.0			23.0/70.0m		25.2/70.0m	22.2	22.8/70.0m	24.3	21.4	21.0	23.6	20.6	70.0
	74.0						20.3/74.0m		22.4/74.0m	19.5	18.1/74.0m	21.6	18.8	74.0
	78.0									17.8		19.9	17.1	78.0
82.0									16.2/82.0m		18.3/82.0m	15.5	82.0	
86.0												14.1/86.0m	86.0	
最大ジブ角度	72.1°	58.4°	50.5°	71.9°	61.8°	50.2°	71.8°	60.7°	50.1°	71.7°	59.7°	49.9°	最大ジブ角度	
最小ジブ角度	19.5°	26.1°	20.6°	23.9°	19.5°	24.7°	17.6°	23.5°	18.6°	21.7°	17.8°	22.5°	最小ジブ角度	
標準掛数	8			8			8			8			標準掛数	

※上表は、ヘビーリフト用マストポイント位置が 16m の場合です。
 ジブが装着された状態では、ブーム吊りはできません。
 上表の場合、補助シーブ吊りはできません。

(単位：t)

ブーム長さ(m)		42.0														ブーム長さ(m)		
ジブ長さ(m)		24.0			30.0			36.0			42.0			48.0			ジブ長さ(m)	
ブーム角度		86°	76°	66°	86°	76°	66°	86°	76°	66°	86°	76°	66°	86°	76°	66°	ブーム角度	
作業半径(m)	15.0	190.9/15.4m															15.0	
	16.0	186.3															16.0	
	17.0	173.5			172.7/17.0m												17.0	
	18.0	162.2			161.5												18.0	
	20.0	143.4			142.8			142.0/20.0m									20.0	
	22.0	128.3			127.7			127.0			126.2/22.0m			125.4/22.0m			22.0	
	24.0	115.9			115.4			114.8			114.0			113.2			24.0	
	26.0	105.6			105.2			104.5			103.8			103.0			26.0	
	28.0	96.7	88.2/28.0m		96.4			95.9			95.1			94.3			28.0	
	30.0	89.1/30.0m	81.3		88.7	80.5/30.0m		88.4			87.7			86.9			30.0	
	34.0		69.9		75.7/34.0m	69.1		75.7	68.6/34.0m		74.9			74.1			34.0	
	38.0		60.7/38.0m	55.4/38.0m		59.9		65.7	59.7		65.0	58.8/38.0m		64.1	57.8/38.0m		38.0	
	42.0			48.8/42.0m		52.7/42.0m	47.8/42.0m	57.9/42.0m	52.5		57.1	51.6		56.3	50.6		42.0	
	46.0						42.4		46.7/46.0m	42.1/46.0m	50.9/46.0m	45.8		50.0	44.8		46.0	
	50.0						38.1/50.0m				37.7		41.0	36.7/50.0m	44.9/50.0m	40.1	50.0	
	54.0										34.1/54.0m		37.1/54.0m	33.1		36.1	32.0/54.0m	54.0
	58.0													30.0		32.8/58.0m	29.0	58.0
62.0													27.4/62.0m			26.4	62.0	
66.0																24.1/66.0m	66.0	
最大ジブ角度		71.5°	57.5°	48.4°	72.1°	60.3°	48.3°	70.2°	58.4°	48.3°	70.2°	57.0°	48.3°	72.8°	61.5°	48.3°	最大ジブ角度	
最小ジブ角度		20.6°	15.4°	33.4°	28.3°	25.6°	20.4°	16.6°	30.5°	27.0°	23.7°	21.4°	17.1°	27.9°	26.2°	23.3°	最小ジブ角度	
標準掛数		16			12			12			12			12			標準掛数	

※上表は、ヘビーリフト用マストポイント位置が16mの場合です。
 ジブが装着された状態では、ブーム吊りはできません。
 上表の場合、補助シーブ吊りはできません。

(単位：t)

ブーム長さ(m)		42.0										ブーム長さ(m)		
ジブ長さ(m)		54.0			60.0			66.0			72.0			ジブ長さ(m)
ブーム角度		86°	76°	66°	86°	76°	66°	86°	76°	66°	86°	76°	66°	ブーム角度
作業半径(m)	24.0	111.9/24.0m												24.0
	26.0	102.3			95.1/26.0m									26.0
	28.0	93.7			92.8			82.4/28.0m						28.0
	30.0	86.3			85.5			78.5			64.8/30.0m			30.0
	34.0	74.3			73.5			70.5			58.9			34.0
	38.0	64.4			63.6			62.8			54.0			38.0
	42.0	56.5	50.7/42.0m		55.8			55.0			47.4			42.0
	46.0	50.2	45.0		49.4	44.1/46.0m		48.5	43.2/46.0m		43.2			46.0
	50.0	45.0	40.2		44.2	39.3		42.8	38.4		39.5	37.6/50.0m		50.0
	54.0	40.6	36.2		39.9	35.3		38.0	34.4		35.9	33.7		54.0
	58.0	36.8/58.0m	32.8	28.7/58.0m	35.4	31.9		33.8	31.1		31.8	30.3		58.0
	62.0		29.9	26.1	31.1/62.0m	29.0	25.2/62.0m	29.5	28.2	24.2/62.0m	28.0	27.4		62.0
	66.0		27.4/66.0m	23.8		26.5	22.9	25.8	25.7	21.9	24.3	24.9	21.1/66.0m	66.0
	70.0			21.7		24.4/70.0m	20.8	22.6/70.0m	23.5	19.9	20.9	22.7	19.1	70.0
	74.0			19.7/74.0m			19.0		21.6	18.1	17.9/74.0m	20.8	17.4	74.0
	78.0						17.3/78.0m		19.9/78.0m	16.5		19.1	15.8	78.0
	82.0									15.0/82.0m		17.6/82.0m	14.2	82.0
86.0												12.9	86.0	
90.0												11.7/90.0m	90.0	
最大ジブ角度		72.5°	60.2°	48.3°	72.3°	59.0°	48.3°	72.2°	62.1°	52.8°	72.0°	61.0°	52.4°	最大ジブ角度
最小ジブ角度		20.8°	18.8°	15.0°	24.9°	23.4°	20.7°	18.8°	17.0°	24.4°	22.6°	21.3°	18.9°	最小ジブ角度
標準掛数		8			8			8			8			標準掛数

※上表は、ヘビーリフト用マストポイント位置が16mの場合です。
 ジブが装着された状態では、ブーム吊りはできません。
 上表の場合、補助シーブ吊りはできません。

(単位：t)

ブーム長さ(m)		48.0														ブーム長さ(m)		
ジブ長さ(m)		24.0			30.0			36.0			42.0			48.0			ジブ長さ(m)	
ブーム角度		86°	76°	66°	86°	76°	66°	86°	76°	66°	86°	76°	66°	86°	76°	66°	ブーム角度	
作業半径(m)	16.0	183.1/16.2m															16.0	
	17.0	172.9			172.2/17.0m												17.0	
	18.0	161.7			161.0												18.0	
	20.0	142.9			142.3			141.5/20.0m									20.0	
	22.0	127.9			127.3			126.6				126.8/22.0m					22.0	
	24.0	115.6			115.1			114.4				113.6			112.7/24.0m		24.0	
	26.0	105.3			104.8			104.2				103.4			102.6		26.0	
	28.0	96.5	86.2/28.0m		96.1			95.5				94.8			94.0		28.0	
	30.0	88.7/30.0m	79.5		88.1			88.1				87.4			86.5		30.0	
	34.0		68.2		75.1/34.0m	67.3/34.0m		75.1	67.0/34.0m			74.4			73.5		34.0	
	38.0		59.1/38.0m			58.3		65.2	58.2			64.5	57.2/38.0m		63.6		38.0	
	42.0			46.5/42.0m		51.2/42.0m		57.4/42.0m	51.1			56.7	50.1		55.8	49.1/42.0m	42.0	
	46.0			41.3/46.0m				40.3/46.0m		45.4		50.4/46.0m	44.5		49.6	43.5	46.0	
	50.0							36.0/50.0m		40.7/50.0m	35.8/50.0m		39.8	34.7/50.0m	44.5	38.8	50.0	
	54.0										32.2		35.9/54.0m	31.2	40.2/54.0m	35.0	30.1/54.0m	54.0
	58.0										29.3/58.0m			28.2		31.7	27.2	58.0
62.0													25.7/62.0m		29.0/62.0m	24.7	62.0	
66.0																22.5	66.0	
70.0																20.7/70.0m	70.0	
最大ジブ角度		70.5°	61.6°	43.1°	73.0°	54.4°	44.2°	70.9°	61.1°	44.9°	70.8°	59.3°	52.6°	70.8°	58.0°	52.1°	最大ジブ角度	
最小ジブ角度		23.4°	25.8°	25.6°	30.0°	31.5°	31.4°	18.9°	20.8°	20.7°	25.1°	26.4°	26.4°	16.2°	17.9°	17.8°	最小ジブ角度	
標準掛数		16			12			12			12			8			標準掛数	

※上表は、ヘビーリフト用マストポイント位置が16mの場合です。
 ジブが装着された状態では、ブーム吊りはできません。
 上表の場合、補助シーブ吊りはできません。

(単位：t)

ブーム長さ(m)		48.0											ブーム長さ(m)		
ジブ長さ(m)		54.0			60.0			66.0			72.0			ジブ長さ(m)	
ブーム角度		86°	76°	66°	86°	76°	66°	86°	76°	66°	86°	76°	66°	ブーム角度	
作業半径(m)	24.0	105.2/24.0m												24.0	
	26.0	101.9			89.5/26.0m									26.0	
	28.0	93.3			88.5			77.0/28.0m						28.0	
	30.0	85.9			85.1			76.2				65.6/30.0m		30.0	
	34.0	73.9			73.1			71.2				58.6		34.0	
	38.0	63.9			63.2			62.4				53.8		38.0	
	42.0	56.1	49.3/42.0m		55.3			54.6				47.9		42.0	
	46.0	49.8	43.7		49.0	42.8/46.0m		48.0				43.6		46.0	
	50.0	44.6	39.0		43.8	38.1		42.1	37.2/50.0m			39.9	36.4/50.0m	50.0	
	54.0	40.3	35.1		39.5	34.2		37.2	33.3			35.1	32.5	54.0	
	58.0	36.4/58.0m	31.8	26.9/58.0m	35.0	30.9		33.1	30.0			30.9	29.2	58.0	
	62.0		28.9	24.4	30.7/62.0m	28.0	23.4/62.0m	29.0	27.1			27.4	26.4	62.0	
	66.0		26.5/66.0m	22.2		25.6	21.3	25.3	24.7	20.3/66.0m		23.8	23.9	66.0	
	70.0			20.2		23.4	19.3	22.1/70.0m	22.5	18.4		20.6	21.8	17.5/70.0m	70.0
	74.0			18.4/74.0m		21.6/74.0m	17.6		20.7	16.6		17.7/74.0m	19.9	15.6	74.0
	78.0						16.0			19.0/78.0m	15.0		18.2	13.9	78.0
82.0						14.5/82.0m					13.6		16.8/82.0m	12.4	82.0
86.0											12.3/86.0m			11.1	86.0
90.0														10.0/90.0m	90.0
最大ジブ角度		73.0°	61.9°	51.7°	72.7°	60.6°	51.3°	72.5°	59.6°	51.1°	72.4°	62.3°	50.8°	最大ジブ角度	
最小ジブ角度		22.1°	23.2°	23.1°	25.8°	16.0°	15.9°	19.9°	20.9°	20.9°	23.5°	24.3°	24.3°	最小ジブ角度	
標準掛数		8			8			8			8			標準掛数	

※上表は、ヘビーリフト用マストポイント位置が16mの場合です。
 ジブが装着された状態では、ブーム吊りはできません。
 上表の場合、補助シーブ吊りはできません。

(単位：t)

ブーム長さ(m)	54.0															ブーム長さ(m)
ジブ長さ(m)	24.0			30.0			36.0			42.0			48.0			ジブ長さ(m)
ブーム角度	86°	76°	66°	86°	76°	66°	86°	76°	66°	86°	76°	66°	86°	76°	66°	ブーム角度
作業半径(m)	17.0	172.2/17.0m														17.0
	18.0	161.0		160.3/18.0m												18.0
	20.0	142.4		141.7			140.9/20.0m									20.0
	22.0	127.4		126.8			126.0				125.2/22.0m					22.0
	24.0	115.1		114.6			113.9				113.0			112.2/24.0m		24.0
	26.0	104.8		104.4			103.7				102.9			102.1		26.0
	28.0	96.1		95.6			95.1				94.3			93.5		28.0
	30.0	88.1/30.0m	77.7/30.0m	87.5			87.6				86.8			86.0		30.0
	34.0		66.5	74.5/34.0m	65.5/34.0m		74.7				73.9			73.0		34.0
	38.0		57.6/38.0m		56.7		64.8	56.6/38.0m			64.0	56.6/38.0m		63.2		38.0
	42.0			44.2/42.0m	49.7		64.8	57.0/42.0m	49.7		56.2	48.7		55.4	47.7/42.0m	42.0
	46.0			39.2/46.0m	44.2/46.0m	38.1/46.0m		44.1			50.0/46.0m	43.1		49.2	42.1	46.0
	50.0					34.0		39.5/50.0m	33.8/50.0m		38.6			44.0	37.6	50.0
	54.0					30.7/54.0m			30.4		34.7	29.3/54.0m	39.9/54.0m	33.8		54.0
	58.0								27.5/58.0m		31.6/58.0m	26.5		30.6	25.4/58.0m	58.0
	62.0											24.0		27.9/62.0m	23.0	62.0
66.0											22.0/66.0m			20.9	66.0	
70.0														19.1/70.0m	70.0	
最大ジブ角度	69.6°	60.1°	51.2°	71.8°	57.8°	50.6°	71.6°	56.3°	50.2°	71.4°	61.6°	49.9°	71.3°	60.0°	49.7°	最大ジブ角度
最小ジブ角度	25.9°	33.1°	37.2°	31.6°	20.0°	24.9°	20.9°	26.7°	30.0°	26.5°	16.7°	20.9°	18.0°	23.0°	25.9°	最小ジブ角度
標準掛数	12			12			12			8			8			標準掛数

※上表は、ヘビーリフト用マストポイント位置が16mの場合です。
 ジブが装着された状態では、ブーム吊りはできません。
 上表の場合、補助シーブ吊りはできません。

(単位：t)

ブーム長さ(m)	54.0												ブーム長さ(m)	
ジブ長さ(m)	54.0			60.0			66.0			72.0			ジブ長さ(m)	
ブーム角度	86°	76°	66°	86°	76°	66°	86°	76°	66°	86°	76°	66°	ブーム角度	
作業半径(m)	26.0	95.8/26.0m											26.0	
	28.0	92.8		82.1/28.0m			72.0/28.0m						28.0	
	30.0	85.5		80.9			71.2			62.2/30.0m			30.0	
	34.0	73.4		72.6			69.3			59.3			34.0	
	38.0	63.5		62.7			61.9			53.4			38.0	
	42.0	55.7		55.0			54.2			48.3			42.0	
	46.0	49.5	42.4/46.0m	48.7	41.4/46.0m		47.9			43.9			46.0	
	50.0	44.3	37.8	43.5	36.9		41.9	35.9/50.0m		40.1			50.0	
	54.0	39.9	34.0	39.2	33.0		36.8	32.1		34.9	31.3/54.0m		54.0	
	58.0	35.9/58.0m	30.7	34.5	29.8		32.7	28.9		30.6	28.1		58.0	
	62.0		27.9	22.7/62.0m	30.2	27.0		28.5	26.1		26.9	25.3	62.0	
	66.0		25.5/66.0m	20.6	26.4/66.0m	24.6	19.6/66.0m	24.8	23.7		23.3	22.9	66.0	
	70.0			18.7		22.5	17.8	21.5/70.0m	21.6	16.5/70.0m	20.1	20.8	70.0	
	74.0			17.0		20.7/74.0m	16.1		19.8	14.7	17.2/74.0m	19.0	13.6/74.0m	74.0
	78.0			15.4/78.0m			14.5		18.2/78.0m	13.1		17.4	12.0	78.0
	82.0						13.1/82.0m			11.7		16.0	10.6	82.0
86.0									10.5		14.6/86.0m	9.3	86.0	
90.0									9.5/90.0m			8.3	90.0	
94.0												7.3/94.0m	94.0	
最大ジブ角度	71.2°	58.8°	49.5°	71.2°	62.2°	49.4°	72.9°	61.0°	49.3°	72.7°	60.0°	49.2°	最大ジブ角度	
最小ジブ角度	23.2°	26.9°	18.4°	16.0°	20.5°	23.0°	21.0°	24.3°	16.6°	24.3°	18.7°	21.0°	最小ジブ角度	
標準掛数	8			8			8			8			標準掛数	

※上表は、ヘビーリフト用マストポイント位置が16mの場合です。
 ジブが装着された状態では、ブーム吊りはできません。
 上表の場合、補助シーブ吊りはできません。

(単位:t)

ブーム長さ(m)		60.0														ブーム長さ(m)		
ジブ長さ(m)		24.0			30.0			36.0			42.0			48.0			ジブ長さ(m)	
ブーム角度		86°	76°	66°	86°	76°	66°	86°	76°	66°	86°	76°	66°	86°	76°	66°	ブーム角度	
作業半径(m)	17.0	162.5/17.8m															17.0	
	18.0	160.3			159.6/18.0m												18.0	
	20.0	141.7			141.0			140.2/20.0m									20.0	
	22.0	126.8			126.2			125.4				121.8/22.0m					22.0	
	24.0	114.6			114.0			113.3				112.5			103.9/24.0m		24.0	
	26.0	104.4			103.9			103.2				102.4			101.5		26.0	
	28.0	95.7			95.0			94.6				93.9			93.0		28.0	
	30.0	87.5/30.0m			86.9			87.1				86.3			85.4		30.0	
	34.0		64.6/34.0m		73.9/34.0m	63.5/34.0m		74.1				73.3			72.5		34.0	
	38.0		55.8			54.9		64.3	54.8/38.0m			63.5			62.7		38.0	
	42.0		49.0/42.0m			48.1		56.6/42.0m	48.1			55.8	47.1/42.0m		54.9	46.0/42.0m		42.0
	46.0			36.8/46.0m		42.7/46.0m			42.6			49.6/46.0m	41.6		48.7	40.6		46.0
	50.0			32.8/50.0m				31.7/50.0m	38.1/50.0m				37.2		43.6	36.1		50.0
	54.0							28.5				28.3/54.0m	33.4		39.4/54.0m	32.4		54.0
	58.0							25.8/58.0m				25.6	30.3/58.0m	24.5/58.0m		29.3		58.0
	62.0											23.2/62.0m			22.2	26.7/62.0m	21.0/62.0m	62.0
	66.0														20.2/66.0m		18.8	66.0
70.0																16.9	70.0	
74.0																15.3/74.0m	74.0	
最大ジブ角度		68.6°	52.7°	46.1°	72.6°	61.1°	46.6°	72.3°	59.0°	46.8°	72.0°	57.6°	47.0°	71.8°	62.0°	47.2°	最大ジブ角度	
最小ジブ角度		28.1°	18.5°	30.3°	33.1°	27.1°	16.1°	22.7°	31.6°	24.5°	27.8°	22.8°	29.0°	19.6°	27.2°	21.1°	最小ジブ角度	
標準掛数		12			12			12			8			8			標準掛数	

※上表は、ヘビーリフト用マストポイント位置が16mの場合です。
 ジブが装着された状態では、ブーム吊りはできません。
 上表の場合、補助シーブ吊りはできません。

(単位:t)

ブーム長さ(m)		60.0										ブーム長さ(m)	
ジブ長さ(m)		54.0			60.0			66.0			72.0		ジブ長さ(m)
ブーム角度		86°	76°	66°	86°	76°	66°	86°	76°	66°	86°	76°	ブーム角度
作業半径(m)	26.0	89.3/26.0m											26.0
	28.0	87.7			76.9/28.0m								28.0
	30.0	85.0			75.6			66.6/30.0m					30.0
	34.0	72.9			72.1			64.5			56.2/34.0m		34.0
	38.0	63.1			62.3			61.5			53.8		38.0
	42.0	55.3			54.5			53.7			48.6		42.0
	46.0	49.1	40.9/46.0m		48.3			47.5			44.2		46.0
	50.0	43.9	36.4		43.1	35.5/50.0m		41.8	34.5/50.0m		40.1		50.0
	54.0	39.6	32.7		38.8	31.8		36.7	30.8		34.8	30.0/54.0m	54.0
	58.0	35.2/58.0m	29.5		33.8	28.6		32.2	27.7		30.4	26.9	58.0
	62.0		26.8	20.7/62.0m	29.5	25.9		27.8	25.0		26.4	24.2	62.0
	66.0		24.5	18.7	25.7/66.0m	23.5	17.5/66.0m	24.1	22.6		22.7	21.8	66.0
	70.0		22.4/70.0m	17.0		21.5	15.6	20.9/70.0m	20.6	14.2/70.0m	19.4	19.8	70.0
	74.0			15.2		19.7/74.0m	13.9		18.8	12.5	16.6	18.0	74.0
78.0			13.7/78.0m			12.4		17.2	11.0	14.1/78.0m	16.3	78.0	
82.0						11.1		15.8/82.0m	9.7		14.7	82.0	
86.0						10.0/86.0m			8.5		13.3/86.0m	86.0	
90.0									7.5/90.0m			90.0	
最大ジブ角度		71.7°	60.6°	52.9°	71.6°	59.4°	52.4°	71.5°	62.5°	52.0°	69.7°	61.4°	最大ジブ角度
最小ジブ角度		24.4°	20.0°	25.5°	17.5°	24.2°	18.8°	22.0°	18.0°	23.0°	15.9°	22.1°	最小ジブ角度
標準掛数		8			8			8			8		標準掛数

※上表は、ヘビーリフト用マストポイント位置が16mの場合です。
 ジブが装着された状態では、ブーム吊りはできません。
 上表の場合、補助シーブ吊りはできません。

(単位：t)

ブーム長さ(m)	66.0															ブーム長さ(m)		
ジブ長さ(m)	24.0			30.0			36.0			42.0			48.0			ジブ長さ(m)		
ブーム角度	86°	76°	66°	86°	76°	66°	86°	76°	66°	86°	76°	66°	86°	76°	66°	ブーム角度		
作業半径(m)	18.0	154.9/18.5m														18.0		
	20.0	141.0			140.3/20.0m			139.4/20.0m								20.0		
	22.0	126.2			125.5			124.7				111.8/22.0m				22.0		
	24.0	114.0			113.4			112.7				109.0			95.8/24.0m	24.0		
	26.0	103.9			103.3			102.6				101.8			93.7	26.0		
	28.0	95.0			94.8			94.1				93.3			91.4	28.0		
	30.0	86.9/30.0m			87.2			86.5				85.7			84.8	30.0		
	34.0		62.5/34.0m		74.3			73.6				72.8			71.9	34.0		
	38.0		54.0		64.4/38.0m	54.0/38.0m		63.8	53.0/38.0m			63.0			62.1	38.0		
	42.0		47.3/42.0m			47.4		56.1/42.0m	46.4			55.3	45.4/42.0m		54.4	42.0		
	46.0					42.0/46.0m			41.1			49.1/46.0m	40.1		48.2	39.0/46.0m	46.0	
	50.0			30.5/50.0m			30.2/50.0m		36.7				35.7		43.2	34.7	50.0	
	54.0			27.4/54.0m			27.2		33.1/54.0m	26.1/54.0m			32.1		39.0/54.0m	31.1	54.0	
	58.0						24.5/58.0m			23.5			29.0/58.0m	22.2/58.0m		28.0	58.0	
	62.0									21.3					19.8	25.4	18.3/62.0m	62.0
	66.0										19.2/66.0m				17.7	23.2/66.0m	16.2	66.0
70.0														15.9/70.0m		14.4	70.0	
74.0																12.9/74.0m	74.0	
最大ジブ角度	67.9°	57.0°	40.6°	69.4°	55.3°	52.7°	73.0°	61.7°	52.0°	72.6°	59.9°	51.5°	72.4°	58.5°	51.1°	最大ジブ角度		
最小ジブ角度	30.3°	27.7°	21.4°	16.1°	32.8°	28.8°	24.5°	22.4°	17.3°	29.0°	27.5°	24.1°	21.1°	19.3°	28.2°	最小ジブ角度		
標準掛数	12			12			12			8			8			標準掛数		

※上表は、ヘビーリフト用マストポイント位置が16mの場合です。
 ジブが装着された状態では、ブーム吊りはできません。
 上表の場合、補助シーブ吊りはできません。

(単位：t)

ブーム長さ(m)	66.0										ブーム長さ(m)
ジブ長さ(m)	54.0			60.0			66.0		72.0		ジブ長さ(m)
ブーム角度	86°	76°	66°	86°	76°	86°	76°	86°	76°	ブーム角度	
作業半径(m)	26.0	82.6/26.0m									26.0
	28.0	81.0			71.3/28.0m						28.0
	30.0	79.3			70.1		61.8/30.0m				30.0
	34.0	72.5			67.3		59.8		52.6/34.0m		34.0
	38.0	62.6			61.8		57.5		50.9		38.0
	42.0	54.9			54.1		53.3		48.8		42.0
	46.0	48.7	39.4/46.0m		47.9		47.1		44.4		46.0
	50.0	43.5	35.0		42.7	34.1/50.0m	41.9		40.3		50.0
	54.0	39.1	31.4		37.7	30.4	36.2	29.5/54.0m	34.9	28.6/54.0m	54.0
	58.0	34.2/58.0m	28.3		32.8	27.4	31.2	26.4	29.9	25.6	58.0
	62.0		25.7		28.6	24.7	26.9	23.8	25.5	23.0	62.0
	66.0		23.4	16.4/66.0m	24.8/66.0m	22.4	23.3	21.5	21.8	20.7	66.0
	70.0		21.4/70.0m	14.6		20.5	20.1/70.0m	19.5	18.6	18.6	70.0
	74.0			13.0		18.7		17.8	15.8	16.7	74.0
	78.0			11.6		17.2/78.0m		16.0	13.4/78.0m	14.9	78.0
	82.0			10.4/82.0m				14.5/82.0m		13.4	82.0
86.0									12.0	86.0	
90.0									10.9/90.0m	90.0	
最大ジブ角度	72.2°	62.3°	50.7°	72.0°	61.0°	71.9°	59.9°	70.1°	62.7°	最大ジブ角度	
最小ジブ角度	25.4°	24.2°	21.2°	18.8°	17.2°	22.9°	21.8°	17.1°	15.7°	最小ジブ角度	
標準掛数	8			8			8		8		標準掛数

※上表は、ヘビーリフト用マストポイント位置が16mの場合です。
 ジブが装着された状態では、ブーム吊りはできません。
 上表の場合、補助シーブ吊りはできません。

▶ ラフティングジブ定格総荷重表 (HL マストポイント半径 16m/ シングルドラム仕様)

(単位 : t)

ブーム長さ(m)		36.0														ブーム長さ(m)	
ジブ長さ(m)		24.0			30.0			36.0			42.0			48.0			ジブ長さ(m)
ブーム角度		86°	76°	66°	86°	76°	66°	86°	76°	66°	86°	76°	66°	86°	76°	66°	ブーム角度
作業半径 (m)	14.0	152.0/14.4m															14.0
	15.0	152.0															15.0
	16.0	152.0															16.0
	17.0	152.0			140.0/17.0m												17.0
	18.0	152.0			140.0			126.0/18.0m									18.0
	20.0	143.7			140.0			126.0			126.0/20.0m						20.0
	22.0	128.5			128.0			126.0			126.0			112.0/22.0m			22.0
	24.0	116.1			115.7			115.1			114.3			112.0			24.0
	26.0	105.7	98.0/26.0m		105.4			104.8			104.1			103.3			26.0
	28.0	96.9	89.9		96.6	89.1/28.0m		96.1			95.4			94.6			28.0
	30.0	86.4/30.0m	82.9		89.1	82.2		88.6			87.9			87.2			30.0
	34.0		71.4/34.0m		76.2/34.0m	70.7		76.1	70.2/34.0m		75.4	69.3/34.0m		74.6			34.0
	38.0			57.6/38.0m		61.4	56.8/38.0m	66.1/38.0m	61.2		65.4	60.3		64.6	59.3/38.0m		38.0
	42.0			50.8/42.0m		54.1/42.0m	50.0		53.8	49.5/42.0m	57.6	52.9		56.7	52.0		42.0
	46.0						44.5/46.0m		47.9/46.0m	44.1	51.3/46.0m	47.0	43.1/46.0m	50.4	46.1		46.0
	50.0									39.6		42.2/50.0m	38.6	45.3/50.0m	41.3	37.6/50.0m	50.0
	54.0									35.7/54.0m			34.8		37.3	33.8	54.0
58.0												31.7/58.0m		33.9/58.0m	30.7	58.0	
62.0															28.0/62.0m	62.0	
最大ジブ角度		73.0°	59.1°	39.8°	71.3°	61.5°	52.3°	72.8°	55.6°	51.6°	72.5°	61.1°	51.1°	72.3°	59.5°	50.7°	最大ジブ角度
最小ジブ角度		17.3°	31.4°	20.0°	26.5°	17.8°	27.9°	31.1°	25.4°	16.1°	22.8°	29.7°	23.4°	26.8°	21.9°	27.7°	最小ジブ角度
標準掛数		11			10			9			9			8			標準掛数

※上表は、ヘビーリフト用マストポイント位置が 16m の場合です。
ジブが装着された状態では、ブーム吊りはできません。

(単位 : t)

ブーム長さ(m)		36.0											ブーム長さ(m)	
ジブ長さ(m)		54.0			60.0			66.0			72.0			ジブ長さ(m)
ブーム角度		86°	76°	66°	86°	76°	66°	86°	76°	66°	86°	76°	66°	ブーム角度
作業半径 (m)	24.0	98.0/24.0m												24.0
	26.0	98.0			98.0/26.0m									26.0
	28.0	94.0			93.1			82.1/28.0m						28.0
	30.0	86.5			85.7			77.6			64.3/30.0m			30.0
	34.0	74.5			73.7			69.8			59.8			34.0
	38.0	64.8			64.0			63.2			54.0			38.0
	42.0	56.9	52.0/42.0m		56.1	51.1/42.0m		55.4			47.0			42.0
	46.0	50.5	46.2		49.8	45.3		49.0	44.4/46.0m		42.8			46.0
	50.0	45.3	41.3		44.5	40.5		43.8	39.6		39.2	38.8/50.0m		50.0
	54.0	40.9	37.2	33.6/54.0m	40.2	36.4		39.0	35.5		36.0	34.8		54.0
	58.0	37.2/58.0m	33.8	30.4	35.7	32.9	29.5/58.0m	34.0	32.1		32.6	31.3		58.0
	62.0		30.8/62.0m	27.6	31.5/62.0m	30.0	26.8	29.8	29.1	25.8/62.0m	28.3	28.4		62.0
	66.0			25.2		27.4	24.4	26.1	26.6	23.5	24.4	25.8	22.7/66.0m	66.0
	70.0			23.0/70.0m		25.2/70.0m	22.2	22.8/70.0m	24.3	21.4	21.0	23.6	20.6	70.0
	74.0						20.3/74.0m		22.4/74.0m	19.5	18.1/74.0m	21.6	18.8	74.0
	78.0									17.8		19.9	17.1	78.0
	82.0										16.2/82.0m	18.3/82.0m	15.5	82.0
86.0												14.1/86.0m	86.0	
最大ジブ角度		72.1°	58.4°	50.5°	71.9°	61.8°	50.2°	71.8°	60.7°	50.1°	71.7°	59.7°	49.9°	最大ジブ角度
最小ジブ角度		19.5°	26.1°	20.6°	23.9°	19.5°	24.7°	17.6°	23.5°	18.6°	21.7°	17.8°	22.5°	最小ジブ角度
標準掛数		7			7			6			5			標準掛数

※上表は、ヘビーリフト用マストポイント位置が 16m の場合です。
ジブが装着された状態では、ブーム吊りはできません。

(単位：t)

ブーム長さ(m)		42.0															ブーム長さ(m)	
ジブ長さ(m)		24.0			30.0			36.0			42.0			48.0			ジブ長さ(m)	
ブーム角度		86°	76°	66°	86°	76°	66°	86°	76°	66°	86°	76°	66°	86°	76°	66°	ブーム角度	
作業半径(m)	15.0	140.0/15.4m															15.0	
	16.0	140.0															16.0	
	17.0	140.0			126.0/17.0m												17.0	
	18.0	140.0			126.0												18.0	
	20.0	140.0			126.0			126.0/20.0m									20.0	
	22.0	128.3			126.0			126.0			112.0/22.0m			98.0/22.0m			22.0	
	24.0	115.9			115.4			114.8			112.0			98.0			24.0	
	26.0	105.6			105.2			104.5			103.8			98.0			26.0	
	28.0	96.7	88.2/28.0m		96.4			95.9			95.1			94.3			28.0	
	30.0	89.1/30.0m	81.3		88.7	80.5/30.0m		88.4			87.7			86.9			30.0	
	34.0		69.9		75.7/34.0m	69.1		75.7	68.6/34.0m		74.9			74.1			34.0	
	38.0		60.7/38.0m	55.4/38.0m		59.9		65.7	59.7		65.0	58.8/38.0m		64.1	57.8/38.0m		38.0	
	42.0			48.8/42.0m		52.7/42.0m	47.8/42.0m	57.9/42.0m	52.5		57.1	51.6		56.3	50.6		42.0	
	46.0						42.4		46.7/46.0m	42.1/46.0m	50.9/46.0m	45.8		50.0	44.8		46.0	
	50.0						38.1/50.0m				37.7		41.0	36.7/50.0m	44.9/50.0m	40.1	50.0	
	54.0										34.1/54.0m		37.1/54.0m	33.1		36.1	32.0/54.0m	54.0
	58.0													30.0		32.8/58.0m	29.0	58.0
62.0													27.4/62.0m			26.4	62.0	
66.0																24.1/66.0m	66.0	
最大ジブ角度	71.5°	57.5°	48.4°	72.1°	60.3°	48.3°	70.2°	58.4°	48.3°	70.2°	57.0°	48.3°	72.8°	61.5°	48.3°	最大ジブ角度		
最小ジブ角度	20.6°	15.4°	33.4°	28.3°	25.6°	20.4°	16.6°	30.5°	27.0°	23.7°	21.4°	17.1°	27.9°	26.2°	23.3°	最小ジブ角度		
標準掛数	10			9			9			8			7			標準掛数		

※上表は、ヘビーリフト用マストポイント位置が16mの場合です。
ジブが装着された状態では、ブーム吊りはできません。

(単位：t)

ブーム長さ(m)		42.0											ブーム長さ(m)	
ジブ長さ(m)		54.0			60.0			66.0			72.0		ジブ長さ(m)	
ブーム角度		86°	76°	66°	86°	76°	66°	86°	76°	66°	86°	76°	66°	ブーム角度
作業半径(m)	24.0	98.0/24.0m												24.0
	26.0	98.0			84.0/26.0m									26.0
	28.0	93.7			84.0			82.4/28.0m						28.0
	30.0	86.3			84.0			78.5			64.8/30.0m			30.0
	34.0	74.3			73.5			70.5			58.9			34.0
	38.0	64.4			63.6			62.8			54.0			38.0
	42.0	56.5	50.7/42.0m		55.8			55.0			47.4			42.0
	46.0	50.2	45.0		49.4	44.1/46.0m		48.5	43.2/46.0m		43.2			46.0
	50.0	45.0	40.2		44.2	39.3		42.8	38.4		39.5	37.6/50.0m		50.0
	54.0	40.6	36.2		39.9	35.3		38.0	34.4		35.9	33.7		54.0
	58.0	36.8/58.0m	32.8	28.7/58.0m	35.4	31.9		33.8	31.1		31.8	30.3		58.0
	62.0		29.9	26.1	31.1/62.0m	29.0	25.2/62.0m	29.5	28.2	24.2/62.0m	28.0	27.4		62.0
	66.0		27.4/66.0m	23.8		26.5	22.9	25.8	25.7	21.9	24.3	24.9	21.1/66.0m	66.0
	70.0			21.7		24.4/70.0m	20.8	22.6/70.0m	23.5	19.9	20.9	22.7	19.1	70.0
	74.0			19.7/74.0m			19.0		21.6	18.1	17.9/74.0m	20.8	17.4	74.0
	78.0						17.3/78.0m		19.9/78.0m	16.5		19.1	15.8	78.0
	82.0									15.0/82.0m		17.6/82.0m	14.2	82.0
86.0												12.9	86.0	
90.0												11.7/90.0m	90.0	
最大ジブ角度	72.5°	60.2°	48.3°	72.3°	59.0°	48.3°	72.2°	62.1°	52.8°	72.0°	61.0°	52.4°	最大ジブ角度	
最小ジブ角度	20.8°	18.8°	15.0°	24.9°	23.4°	20.7°	18.8°	17.0°	24.4°	22.6°	21.3°	18.9°	最小ジブ角度	
標準掛数	7			6			6			5		標準掛数		

※上表は、ヘビーリフト用マストポイント位置が16mの場合です。
ジブが装着された状態では、ブーム吊りはできません。

(単位:t)

ブーム長さ(m)		48.0														ブーム長さ(m)	
ジブ長さ(m)		24.0			30.0			36.0			42.0			48.0			ジブ長さ(m)
ブーム角度		86°	76°	66°	86°	76°	66°	86°	76°	66°	86°	76°	66°	86°	76°	66°	ブーム角度
作業半径(m)	16.0	126.0/16.2m															16.0
	17.0	126.0			126.0/17.0m												17.0
	18.0	126.0			126.0												18.0
	20.0	126.0			126.0			112.0/20.0m									20.0
	22.0	126.0			126.0			112.0			98.0/22.0m						22.0
	24.0	115.6			115.1			112.0			98.0			98.0/24.0m			24.0
	26.0	105.3			104.8			104.2			98.0			98.0			26.0
	28.0	96.5	86.2/28.0m		96.1			95.5			94.8			94.0			28.0
	30.0	88.7/30.0m	79.5		88.1			88.1			87.4			86.5			30.0
	34.0		68.2		75.1/34.0m	67.3/34.0m		75.1	67.0/34.0m		74.4			73.5			34.0
	38.0		59.1/38.0m			58.3		65.2	58.2		64.5	57.2/38.0m		63.6			38.0
	42.0			46.5/42.0m		51.2/42.0m		57.4/42.0m	51.1		56.7	50.1		55.8	49.1/42.0m		42.0
	46.0			41.3/46.0m			40.3/46.0m		45.4		50.4/46.0m	44.5		49.6	43.5		46.0
	50.0						36.0/50.0m		40.7/50.0m	35.8/50.0m		39.8	34.7/50.0m	44.5	38.8		50.0
	54.0									32.2		35.9/54.0m	31.2	40.2/54.0m	35.0	30.1/54.0m	54.0
	58.0									29.3/58.0m			28.2		31.7	27.2	58.0
	62.0												25.7/62.0m		29.0/62.0m	24.7	62.0
66.0															22.5	66.0	
70.0															20.7/70.0m	70.0	
最大ジブ角度		70.5°	61.6°	43.1°	73.0°	54.4°	44.2°	70.9°	61.1°	44.9°	70.8°	59.3°	52.6°	70.8°	58.0°	52.1°	最大ジブ角度
最小ジブ角度		23.4°	25.8°	25.6°	30.0°	31.5°	31.4°	18.9°	20.8°	20.7°	25.1°	26.4°	26.4°	16.2°	17.9°	17.8°	最小ジブ角度
標準掛数		9			9			8			7			7			標準掛数

※上表は、ヘビーリフト用マストポイント位置が16mの場合です。
ジブが装着された状態では、ブーム吊りはできません。

(単位:t)

ブーム長さ(m)		48.0														ブーム長さ(m)
ジブ長さ(m)		54.0			60.0			66.0			72.0			ジブ長さ(m)		
ブーム角度		86°	76°	66°	86°	76°	66°	86°	76°	66°	86°	76°	66°	ブーム角度		
作業半径(m)	24.0	84.0/24.0m														24.0
	26.0	84.0			84.0/26.0m											26.0
	28.0	84.0			84.0			70.0/28.0m								28.0
	30.0	84.0			84.0			70.0			66.6/30.0m					30.0
	34.0	73.9			73.1			70.0			58.6					34.0
	38.0	63.9			63.2			62.4			53.8					38.0
	42.0	56.1	49.3/42.0m		55.3			54.6			47.9					42.0
	46.0	49.8	43.7		49.0	42.8/46.0m		48.0			43.6					46.0
	50.0	44.6	39.0		43.8	38.1		42.1	37.2/50.0m		39.9	36.4/50.0m				50.0
	54.0	40.3	35.1		39.5	34.2		37.2	33.3		35.1	32.5				54.0
	58.0	36.4/58.0m	31.8	26.9/58.0m	35.0	30.9		33.1	30.0		30.9	29.2				58.0
	62.0		28.9	24.4	30.7/62.0m	28.0	23.4/62.0m	29.0	27.1		27.4	26.4				62.0
	66.0		26.5/66.0m	22.2		25.6	21.3	25.3	24.7	20.3/66.0m	23.8	23.9				66.0
	70.0			20.2		23.4	19.3	22.1/70.0m	22.5	18.4	20.6	21.8	17.5/70.0m			70.0
	74.0			18.4/74.0m		21.6/74.0m	17.6		20.7	16.6	17.7/74.0m	19.9	15.6			74.0
	78.0						16.0		19.0/78.0m	15.0		18.2	13.9			78.0
	82.0						14.5/82.0m			13.6		16.8/82.0m	12.4			82.0
86.0										12.3/86.0m		11.1			86.0	
90.0												10.0/90.0m			90.0	
最大ジブ角度		73.0°	61.9°	51.7°	72.7°	60.6°	51.3°	72.5°	59.6°	51.1°	72.4°	62.3°	50.8°			最大ジブ角度
最小ジブ角度		22.1°	23.2°	23.1°	25.8°	16.0°	15.9°	19.9°	20.9°	20.9°	23.5°	24.3°	24.3°			最小ジブ角度
標準掛数		6			6			5			5			標準掛数		

※上表は、ヘビーリフト用マストポイント位置が16mの場合です。
ジブが装着された状態では、ブーム吊りはできません。

(単位：t)

ブーム長さ(m)		54.0															ブーム長さ(m)	
ジブ長さ(m)		24.0			30.0			36.0			42.0			48.0			ジブ長さ(m)	
ブーム角度		86°	76°	66°	86°	76°	66°	86°	76°	66°	86°	76°	66°	86°	76°	66°	ブーム角度	
作業半径(m)	17.0	126.0/17.0m															17.0	
	18.0	126.0			112.0/18.0m												18.0	
	20.0	126.0			112.0			98.0/20.0m									20.0	
	22.0	126.0			112.0			98.0			98.0/22.0m						22.0	
	24.0	115.1			112.0			98.0			98.0			84.0/24.0m			24.0	
	26.0	104.8			104.4			98.0			98.0			84.0			26.0	
	28.0	96.1			95.6			95.1			94.3			84.0			28.0	
	30.0	88.1/30.0m	77.7/30.0m		87.5			87.6			86.8			84.0			30.0	
	34.0		66.5		74.5/34.0m	65.5/34.0m		74.7			73.9			73.0			34.0	
	38.0		57.6/38.0m			56.7		64.8	56.6/38.0m		64.0	55.6/38.0m		63.2			38.0	
	42.0			44.2/42.0m		49.7		57.0/42.0m	49.7		56.2	48.7		55.4	47.7/42.0m		42.0	
	46.0			39.2/46.0m		44.2/46.0m	38.1/46.0m		44.1		50.0/46.0m	43.1		49.2	42.1		46.0	
	50.0						34.0		39.5/50.0m	33.8/50.0m		38.6		44.0	37.6		50.0	
	54.0						30.7/54.0m			30.4		34.7	29.3/54.0m	39.9/54.0m	33.8		54.0	
	58.0									27.5/58.0m		31.6/58.0m		26.5		30.6	25.4/58.0m	58.0
	62.0													24.0		27.9/62.0m	23.0	62.0
66.0													22.0/66.0m			20.9	66.0	
70.0																19.1/70.0m	70.0	
最大ジブ角度		69.6°	60.1°	51.2°	71.8°	57.8°	50.6°	71.6°	56.3°	50.2°	71.4°	61.6°	49.9°	71.3°	60.0°	49.7°	最大ジブ角度	
最小ジブ角度		25.9°	33.1°	37.2°	31.6°	20.0°	24.9°	20.9°	26.7°	30.0°	26.5°	16.7°	20.9°	18.0°	23.0°	25.9°	最小ジブ角度	
標準掛数		9			8			7			7			6			標準掛数	

※上表は、ヘビーリフト用マストポイント位置が16mの場合です。
ジブが装着された状態では、ブーム吊りはできません。

(単位：t)

ブーム長さ(m)		54.0												ブーム長さ(m)
ジブ長さ(m)		54.0			60.0			66.0			72.0			ジブ長さ(m)
ブーム角度		86°	76°	66°	86°	76°	66°	86°	76°	66°	86°	76°	66°	ブーム角度
作業半径(m)	26.0	84.0/26.0m												26.0
	28.0	84.0			82.1/28.0m			70.0/28.0m						28.0
	30.0	84.0			80.9			70.0			56.0/30.0m			30.0
	34.0	73.4			72.6			69.3			56.0			34.0
	38.0	63.5			62.7			61.9			53.4			38.0
	42.0	55.7			55.0			54.2			48.3			42.0
	46.0	49.5	42.4/46.0m		48.7	41.4/46.0m		47.9			43.9			46.0
	50.0	44.3	37.8		43.5	36.9		41.9	35.9/50.0m		40.1			50.0
	54.0	39.9	34.0		39.2	33.0		36.8	32.1		34.9	31.3/54.0m		54.0
	58.0	35.9/58.0m	30.7		34.5	29.8		32.7	28.9		30.6	28.1		58.0
	62.0		27.9	22.7/62.0m	30.2	27.0		28.5	26.1		26.9	25.3		62.0
	66.0		25.5/66.0m	20.6	26.4/66.0m	24.6	19.6/66.0m	24.8	23.7		23.3	22.9		66.0
	70.0			18.7		22.5	17.8	21.5/70.0m	21.6	16.5/70.0m	20.1	20.8		70.0
	74.0			17.0		20.7/74.0m	16.1		19.8	14.7	17.2/74.0m	19.0	13.6/74.0m	74.0
	78.0			15.4/78.0m			14.5		18.2/78.0m	13.1		17.4	12.0	78.0
	82.0						13.1/82.0m			11.7		16.0	10.6	82.0
86.0									10.5		14.6/86.0m	9.3	86.0	
90.0									9.5/90.0m			8.3	90.0	
94.0												7.3/94.0m	94.0	
最大ジブ角度		71.2°	58.8°	49.5°	71.2°	62.2°	49.4°	72.9°	61.0°	49.3°	72.7°	60.0°	49.2°	最大ジブ角度
最小ジブ角度		23.2°	26.9°	18.4°	16.0°	20.5°	23.0°	21.0°	24.3°	16.6°	24.3°	18.7°	21.0°	最小ジブ角度
標準掛数		6			6			5			4			標準掛数

※上表は、ヘビーリフト用マストポイント位置が16mの場合です。
ジブが装着された状態では、ブーム吊りはできません。

(単位:t)

ブーム長さ(m)		60.0														ブーム長さ(m)	
ジブ長さ(m)		24.0			30.0			36.0			42.0			48.0			ジブ長さ(m)
ブーム角度		86°	76°	66°	86°	76°	66°	86°	76°	66°	86°	76°	66°	86°	76°	66°	ブーム角度
作業半径(m)	17.0	112.0/17.8m															17.0
	18.0	112.0			98.0/18.0m												18.0
	20.0	112.0			98.0			98.0/20.0m									20.0
	22.0	112.0			98.0			98.0			84.0/22.0m						22.0
	24.0	112.0			98.0			98.0			84.0			84.0/24.0m			24.0
	26.0	104.4			98.0			98.0			84.0			84.0			26.0
	28.0	95.7			95.0			94.6			84.0			84.0			28.0
	30.0	87.5/30.0m			86.9			87.1			84.0			84.0			30.0
	34.0		64.6/34.0m		73.9/34.0m	63.5/34.0m		74.1			73.3			72.5			34.0
	38.0		55.8			54.9		64.3	54.8/38.0m		63.5			62.7			38.0
	42.0		49.0/42.0m			48.1		56.6/42.0m	48.1		55.8	47.1/42.0m		54.9	46.0/42.0m		42.0
	46.0			36.8/46.0m		42.7/46.0m			42.6		49.6/46.0m	41.6		48.7	40.6		46.0
	50.0			32.8/50.0m			31.7/50.0m		38.1/50.0m			37.2		43.6	36.1		50.0
	54.0						28.5			28.3/54.0m		33.4		39.4/54.0m	32.4		54.0
	58.0						25.8/58.0m			25.6		30.3/58.0m	24.5/58.0m		29.3		58.0
	62.0									23.2/62.0m			22.2		26.7/62.0m	21.0/62.0m	62.0
	66.0												20.2/66.0m			18.8	66.0
70.0															16.9	70.0	
74.0															15.3/74.0m	74.0	
最大ジブ角度		68.6°	52.7°	46.1°	72.6°	61.1°	46.6°	72.3°	59.0°	46.8°	72.0°	57.6°	47.0°	71.8°	62.0°	47.2°	最大ジブ角度
最小ジブ角度		28.1°	18.5°	30.3°	33.1°	27.1°	16.1°	22.7°	31.6°	24.5°	27.8°	22.8°	29.0°	19.6°	27.2°	21.1°	最小ジブ角度
標準掛数		8			7			7			6			6			標準掛数

※上表は、ヘビーリフト用マストポイント位置が16mの場合です。
ジブが装着された状態では、ブーム吊りはできません。

(単位:t)

ブーム長さ(m)		60.0										ブーム長さ(m)	
ジブ長さ(m)		54.0			60.0			66.0			72.0		ジブ長さ(m)
ブーム角度		86°	76°	66°	86°	76°	66°	86°	76°	66°	86°	76°	ブーム角度
作業半径(m)	26.0	84.0/26.0m											26.0
	28.0	84.0			70.0/28.0m								28.0
	30.0	84.0			70.0			66.6/30.0m					30.0
	34.0	72.9			70.0			64.5			56.0/34.0m		34.0
	38.0	63.1			62.3			61.5			53.8		38.0
	42.0	55.3			54.5			53.7			48.6		42.0
	46.0	49.1	40.9/46.0m		48.3			47.5			44.2		46.0
	50.0	43.9	36.4		43.1	35.5/50.0m		41.8	34.5/50.0m		40.1		50.0
	54.0	39.6	32.7		38.8	31.8		36.7	30.8		34.8	30.0/54.0m	54.0
	58.0	35.2/58.0m	29.5		33.8	28.6		32.2	27.7		30.4	26.9	58.0
	62.0		26.8	20.7/62.0m	29.5	25.9		27.8	25.0		26.4	24.2	62.0
	66.0		24.5	18.7	25.7/66.0m	23.5	17.5/66.0m	24.1	22.6		22.7	21.8	66.0
	70.0		22.4/70.0m	17.0		21.5	15.6	20.9/70.0m	20.6	14.2/70.0m	19.4	19.8	70.0
	74.0			15.2		19.7/74.0m	13.9		18.8	12.5	16.6	18.0	74.0
	78.0			13.7/78.0m			12.4		17.2	11.0	14.1/78.0m	16.3	78.0
82.0						11.1		15.8/82.0m	9.7		14.7	82.0	
86.0						10.0/86.0m			8.5		13.3/86.0m	86.0	
90.0									7.5/90.0m			90.0	
最大ジブ角度		71.7°	60.6°	52.9°	71.6°	59.4°	52.4°	71.5°	62.5°	52.0°	69.7°	61.4°	最大ジブ角度
最小ジブ角度		24.4°	20.0°	25.5°	17.5°	24.2°	18.8°	22.0°	18.0°	23.0°	15.9°	22.1°	最小ジブ角度
標準掛数		6			5			5			4		標準掛数

※上表は、ヘビーリフト用マストポイント位置が16mの場合です。
ジブが装着された状態では、ブーム吊りはできません。

(単位：t)

ブーム長さ(m)	66.0															ブーム長さ(m)	
ジブ長さ(m)	24.0			30.0			36.0			42.0			48.0			ジブ長さ(m)	
ブーム角度	86°	76°	66°	86°	76°	66°	86°	76°	66°	86°	76°	66°	86°	76°	66°	ブーム角度	
作業半径(m)	18.0	98.0/18.5m														18.0	
	20.0	98.0			98.0/20.0m			84.0/20.0m								20.0	
	22.0	98.0			98.0			84.0			84.0/22.0m					22.0	
	24.0	98.0			98.0			84.0			84.0			84.0/24.0m		24.0	
	26.0	98.0			98.0			84.0			84.0			84.0		26.0	
	28.0	95.0			94.8			84.0			84.0			84.0		28.0	
	30.0	86.9/30.0m			87.2			84.0			84.0			84.0		30.0	
	34.0		62.5/34.0m		74.3			73.6			72.8			71.9		34.0	
	38.0		54.0		64.4/38.0m	54.0/38.0m		63.8	53.0/38.0m		63.0			62.1		38.0	
	42.0		47.3/42.0m			47.4		56.1/42.0m	46.4		55.3	45.4/42.0m		54.4		42.0	
	46.0					42.0/46.0m			41.1		49.1/46.0m	40.1		48.2	39.0/46.0m	46.0	
	50.0			30.5/50.0m			30.2/50.0m		36.7			35.7		43.2	34.7	50.0	
	54.0			27.4/54.0m			27.2		33.1/54.0m	26.1/54.0m		32.1		39.0/54.0m	31.1	54.0	
	58.0						24.5/58.0m			23.5		29.0/58.0m	22.2/58.0m		28.0	58.0	
	62.0									21.3				19.8	25.4	18.3/62.0m	62.0
	66.0									19.2/66.0m				17.7	23.2/66.0m	16.2	66.0
70.0													15.9/70.0m		14.4	70.0	
74.0															12.9/74.0m	74.0	
最大ジブ角度	67.9°	57.0°	40.6°	69.4°	55.3°	52.7°	73.0°	61.7°	52.0°	72.6°	59.9°	51.5°	72.4°	58.5°	51.1°	最大ジブ角度	
最小ジブ角度	30.3°	27.7°	21.4°	16.1°	32.8°	28.8°	24.5°	22.4°	17.3°	29.0°	27.5°	24.1°	21.1°	19.3°	28.2°	最小ジブ角度	
標準掛数	7			7			6			6			6			標準掛数	

※上表は、ヘビーリフト用マストポイント位置が16mの場合です。
ジブが装着された状態では、ブーム吊りはできません。

(単位：t)

ブーム長さ(m)	66.0										ブーム長さ(m)
ジブ長さ(m)	54.0			60.0			66.0		72.0		ジブ長さ(m)
ブーム角度	86°	76°	66°	86°	76°	86°	76°	86°	76°	ブーム角度	
作業半径(m)	26.0	70.0/26.0m									26.0
	28.0	70.0			70.0/28.0m						28.0
	30.0	70.0			70.0			56.0/30.0m			30.0
	34.0	70.0			67.3			56.0	52.6/34.0m		34.0
	38.0	62.6			61.8			56.0	50.9		38.0
	42.0	54.9			54.1			53.3	48.8		42.0
	46.0	48.7	39.4/46.0m		47.9			47.1	44.4		46.0
	50.0	43.5	35.0		42.7	34.1/50.0m		41.9	40.3		50.0
	54.0	39.1	31.4		37.7	30.4	36.2	29.5/54.0m	34.9	28.6/54.0m	54.0
	58.0	34.2/58.0m	28.3		32.8	27.4	31.2	26.4	29.9	25.6	58.0
	62.0		25.7		28.6	24.7	26.9	23.8	25.5	23.0	62.0
	66.0		23.4	16.4/66.0m	24.8/66.0m	22.4	23.3	21.5	21.8	20.7	66.0
	70.0		21.4/70.0m	14.6		20.5	20.1/70.0m	19.5	18.6	18.6	70.0
	74.0			13.0		18.7		17.8	15.8	16.7	74.0
	78.0			11.6		17.2/78.0m		16.0	13.4/78.0m	14.9	78.0
	82.0			10.4/82.0m				14.5/82.0m		13.4	82.0
86.0									12.0	86.0	
90.0									10.9/90.0m	90.0	
最大ジブ角度	72.2°	62.3°	50.7°	72.0°	61.0°	71.9°	59.9°	70.1°	62.7°	最大ジブ角度	
最小ジブ角度	25.4°	24.2°	21.2°	18.8°	17.2°	22.9°	21.8°	17.1°	15.7°	最小ジブ角度	
標準掛数	5			5			4		4		標準掛数

※上表は、ヘビーリフト用マストポイント位置が16mの場合です。
ジブが装着された状態では、ブーム吊りはできません。